

- NOTES:
1. DISPLAY TYPE: TN
 2. POLARIZER MODE: TRANSMISSIVE/POSITIVE.
 3. DRIVE METHOD: STATIC.
 4. OPERATING VOLTAGE: 3.0V.
 5. VIEWING DIRECTION: 6 O'CLOCK.
 6. OPERATING TEMP: 0°C~+50°C.
 7. STORAGE TEMP: -10°C~+60°C.
 8. CONNECTOR:

CUSTOMER P/N:		MODEL: RT623091	
DRAWN BY: CXT 2010-07-19		UNITS: mm	
CHECKED BY: HWC 2010-07-19		SHEET: 1/4	
DIMENSION TOLERANCE :		REVISION : 0	
		±0.2 mm	

PIN	1	2	3	4	5	6
COM	COM	T1	T2	T3	T4	T5

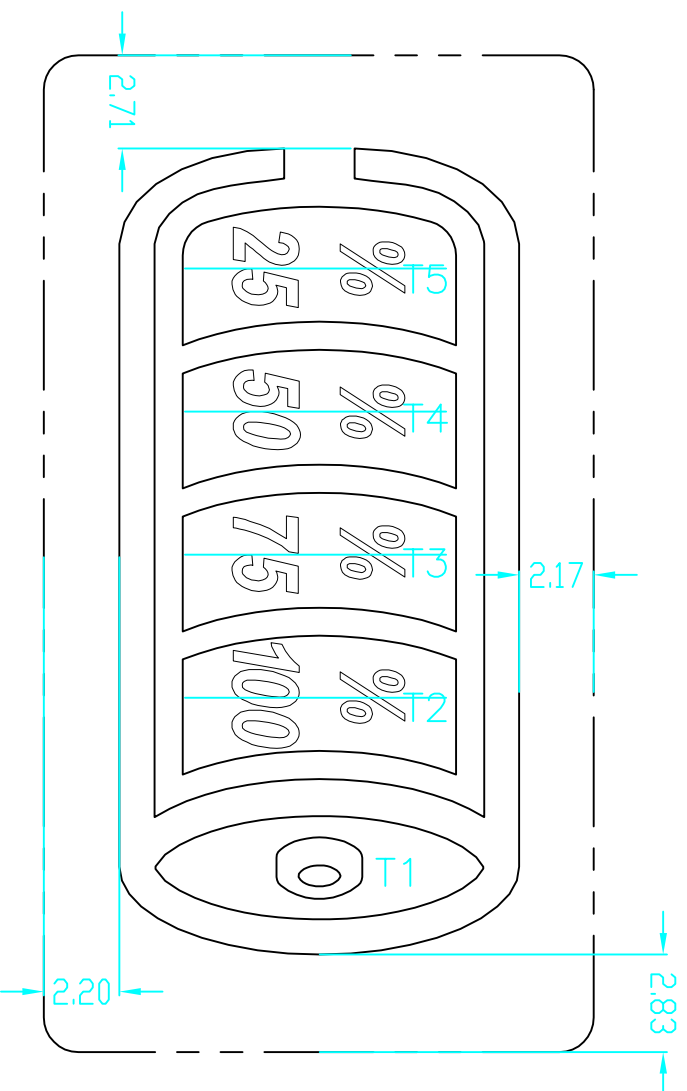

CUSTOMER P/N:		MODEL: RT623091	
DRAWN BY: CXT 2010-07-19		UNITS: mm	
CHECKED BY: HWC 2010-07-19		SHEET: 2/4	
		REVISION : 0	

±0.2 mm

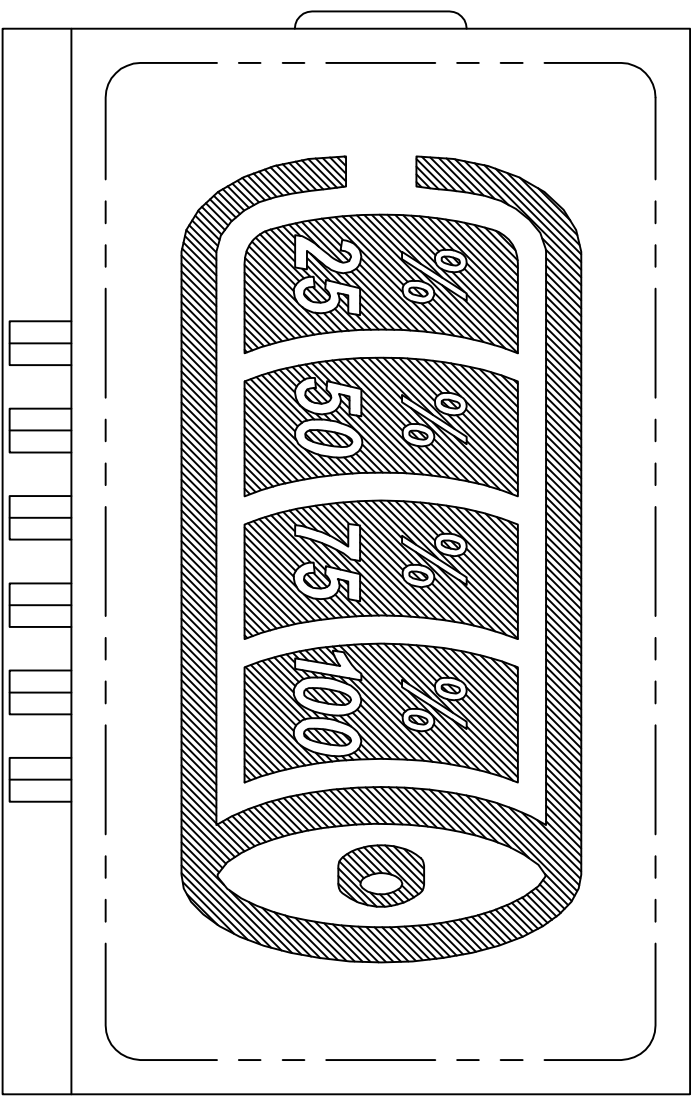

CUSTOMER P/N:

DRAWN BY: CXT 2010-07-19

CHECKED BY: HWC 2010-07-19

MODEL: RT623091

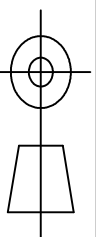

± 0.2 mm

UNITS: mm

SHEET: 3/4

REVISION : 0

发光区

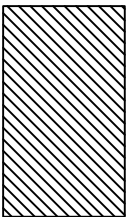
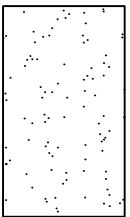

遮光区

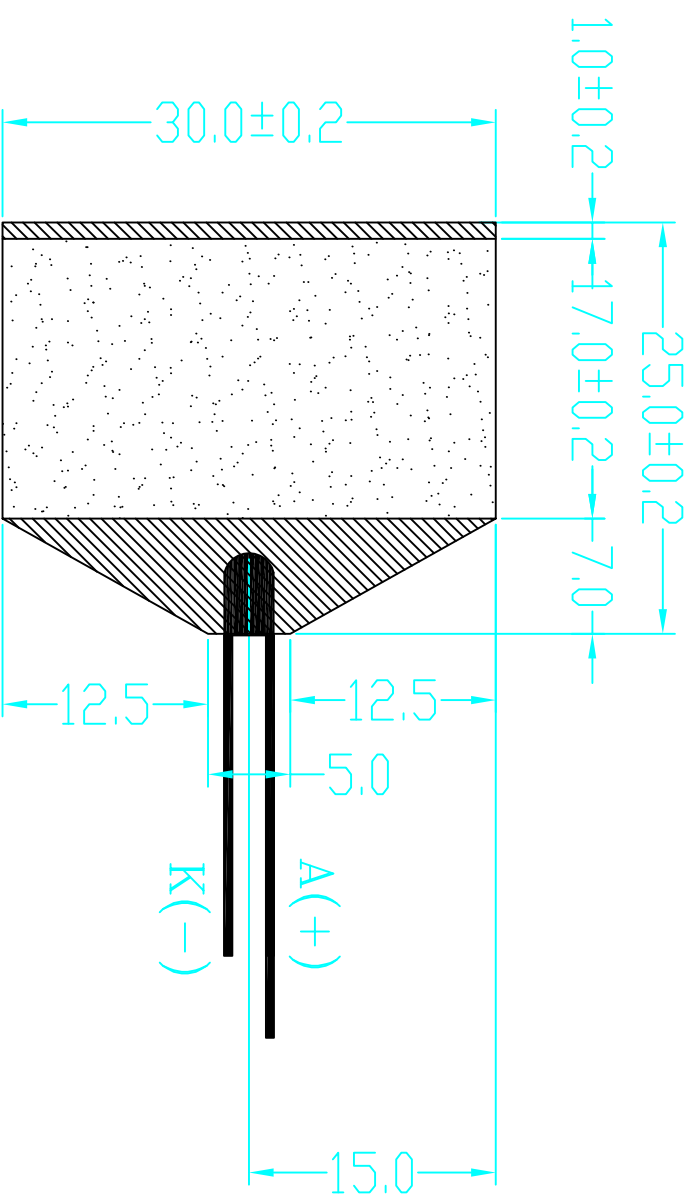

说明:

1. 1个LED
2. 蓝色灯
3. 驱动电压: 3.0V-3.2V
4. 电流: 15 mA
5. 出光均匀性: $\geq 70\%$
6. 工作温度: -20°C 至 $+70^{\circ}\text{C}$
7. 储存温度: -25°C 至 $+75^{\circ}\text{C}$
8. 未标注尺寸公差为 $\pm 0.30\text{mm}$
9. 符合ROHS工艺

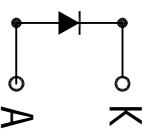
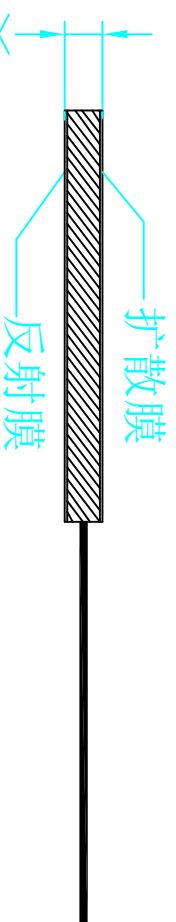

注意保存. 保存条件不好时, 会降低反光膜 (扩散膜) 与导光片 (反射壳) 的粘附力
 推荐保存条件为: 温度 $25^{\circ}\text{C} \pm 10^{\circ}\text{C}$
 湿度 $65\%RH \pm 20\%RH$

CUSTOMER P/N:		MODEL: RT623091	
DRAWN BY: CXT 2010-07-19		UNITS: mm	
CHECKED BY: HWC 2010-07-19		SHEET: 4/4	
±0.2 mm		REVISION : 0	