

Title		
Size	Number	Revision
B		
Date:	7-Sep-2009	Sheet of
File:	E:\MyWork\ARM\LPC1114\Schematic\LCD1114.kicad_pcb	6

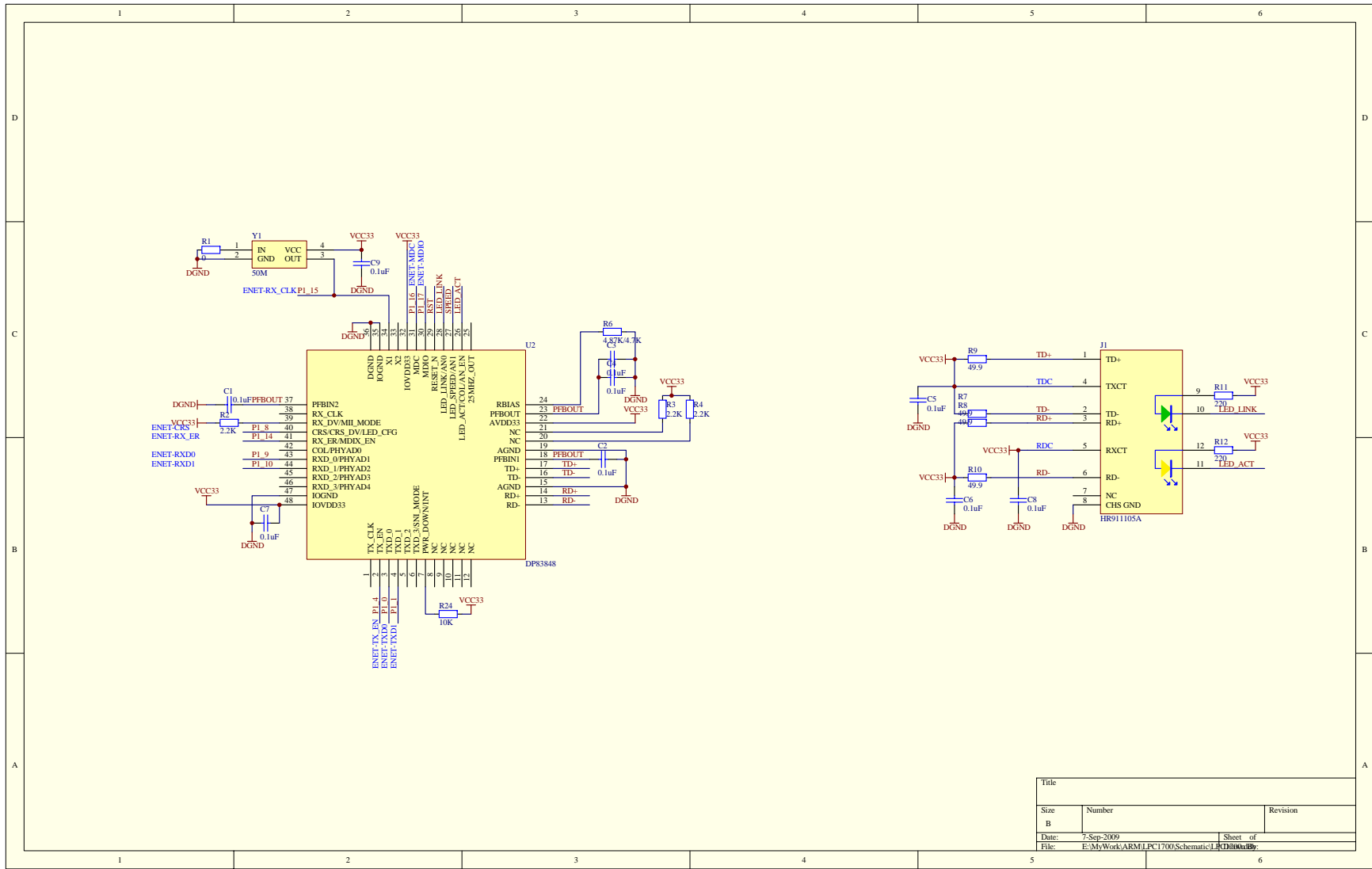

Title		
Size	Number	Revision
B		
Date:	7-Sep-2009	Sheet of
File:	E:\MyWork\ARM\LPCL700\Schematic\LPCL700.kicad_sch	

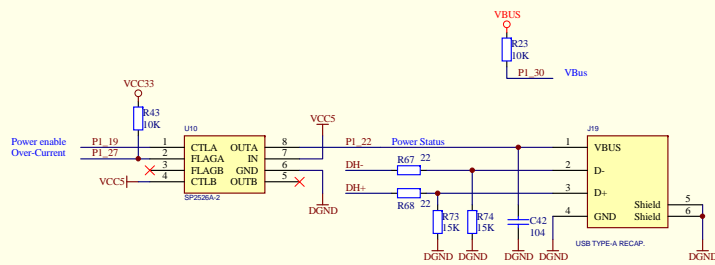
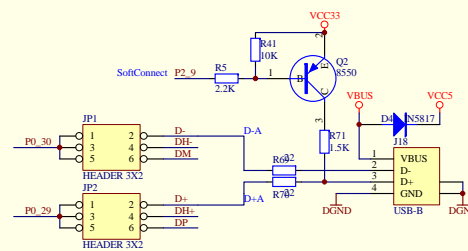
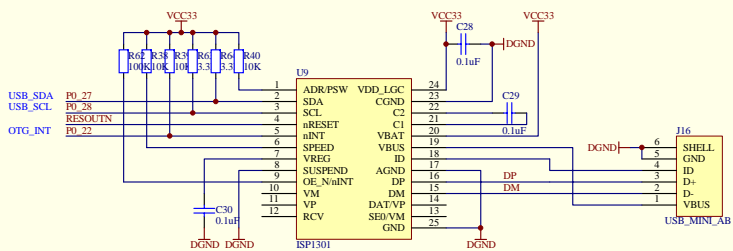

Title		
Size	Number	Revision
B		
Date:	7-Sep-2009	Sheet of
File:	E:\MyWork\ARM\LPCL700\Schematic\PCB\0001.dbr	

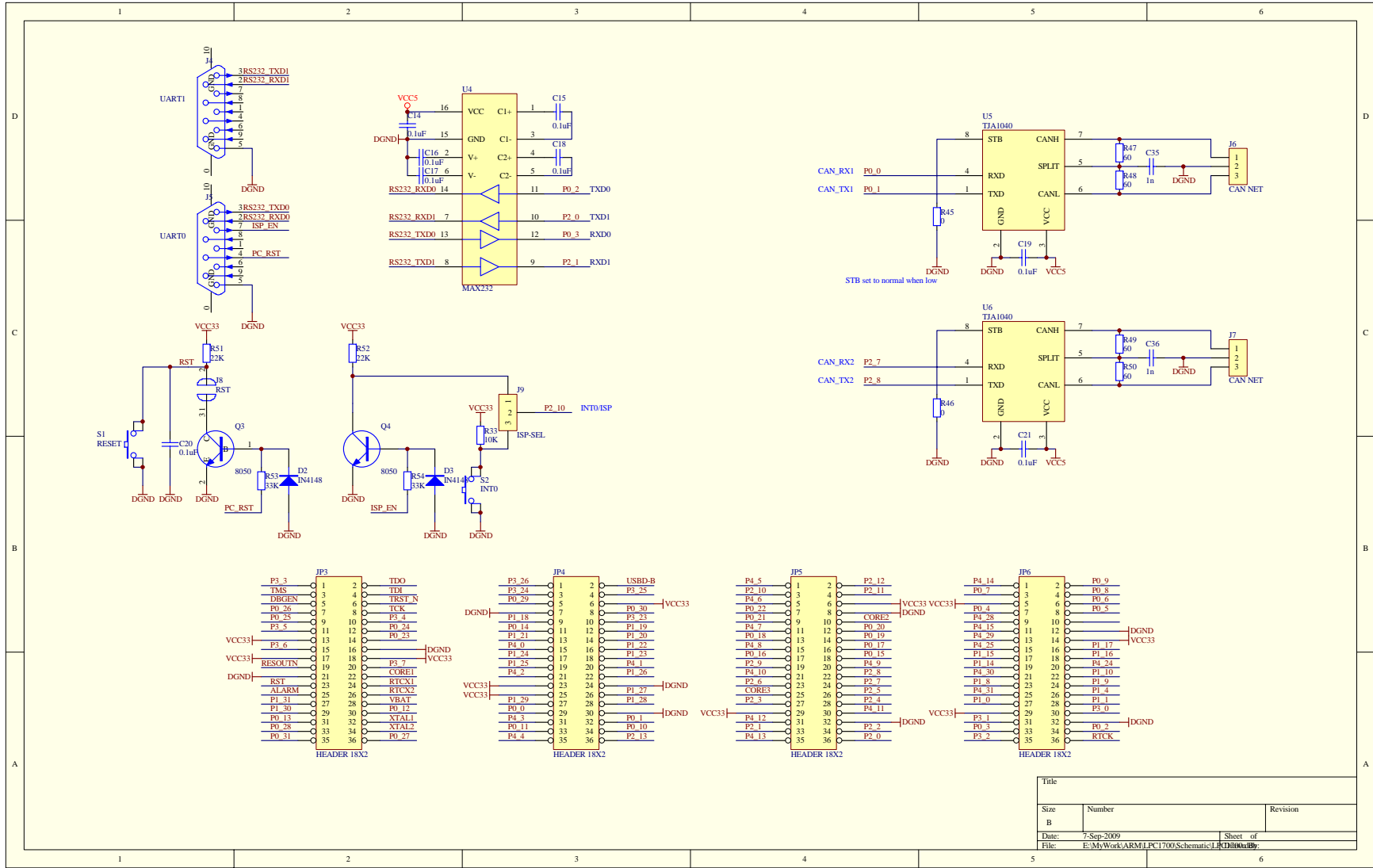

Title		
Size	Number	Revision
B		
Date:	7-Sep-2009	Sheet of
File:	E:\MyWork\ARM\LPC1700\Schematic\PCB0001.dwg	

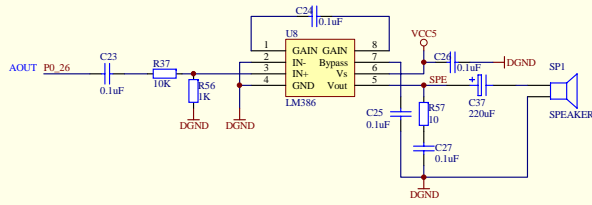
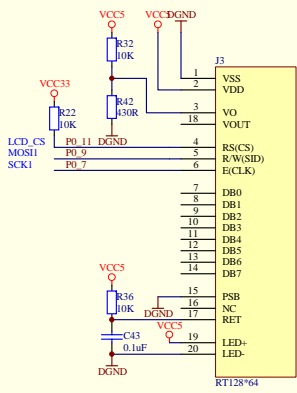
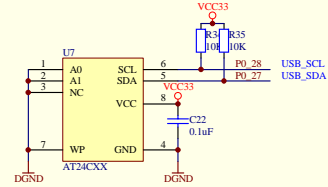
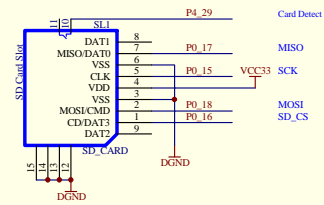

Title		
Size	Number	Revision
B		
Date:	7-Sep-2009	Sheet of
File:	E:\MyWork\ARM\LPC1700\Schematic\LCD1700.kicad	6