

REVISION	DESCRIPTION	CHECK	APP	DATE	REV. NOTICE. NO
△1					
△2					
△3					

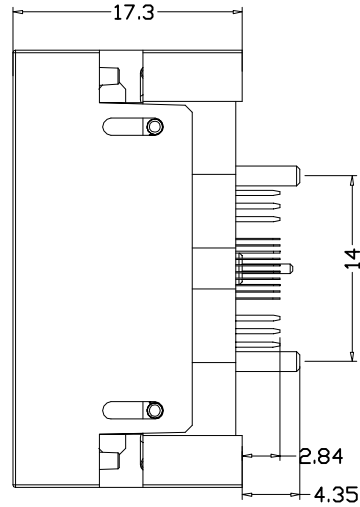

PCB Pattern(TOP View)

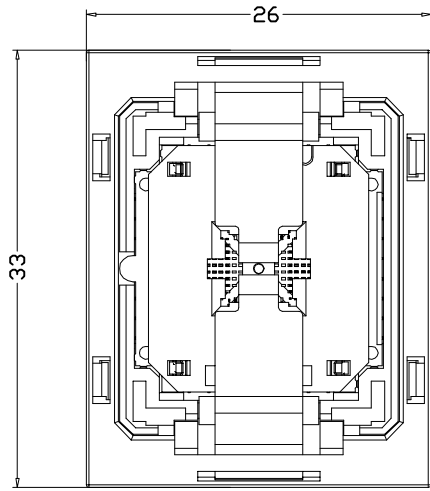
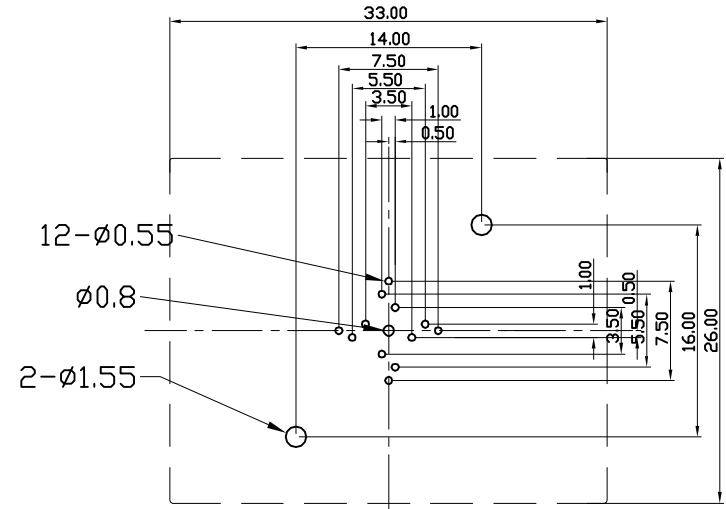

Applicable IC

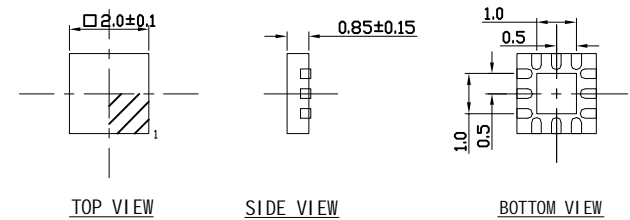
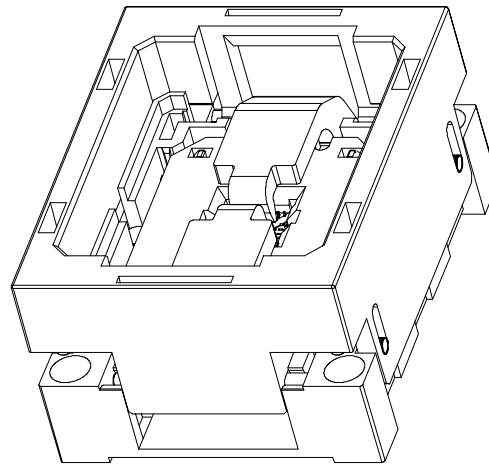
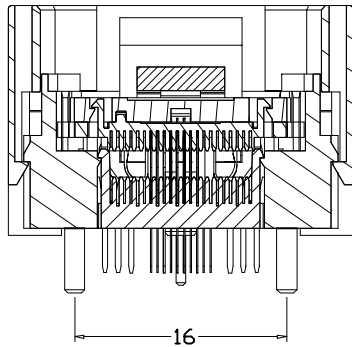

**PERFORMANCE**

1. Insulation Resistance: 1000MΩ Min.At DC 500V
2. Dielectric Withstanding Voltage For 1 Minute At AC 700V
3. Contact Resistance 30mΩ MAX. at 10mA and 20mV MAX.(Initial)
4. Current Rating: 1A max.
5. Operation Temperature -40°C ~+155°C
6. Contact Force 8-10g Per Pin (Normal)
7. Life Span 15,000 Times (Mechanical)
8. Operation Force 2.0 Kg MAX

PROJECTION		GENERAL TOLERANCES	±0.10	TITLE	QFN12-0.5 SOCKET
		R E V	A	CLASS	QFN012-0.5-TP01G
DIMENSION:	mm	SCALE:	1:1	DRW. NO	QFN012-0.5-TP01G-A-01
APP:		DATE:			
CHECK:		DATE:			
DECK:		DATE:	20120822		