

A

B

C

D

E

F

1

2

3

4

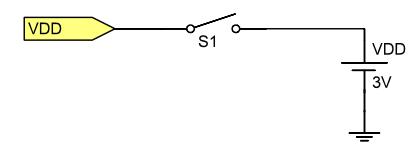
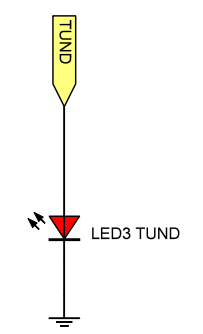
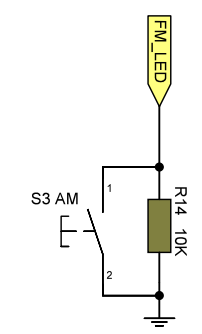
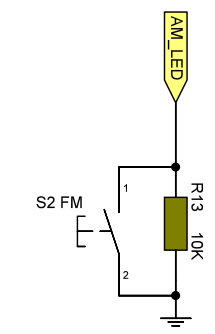
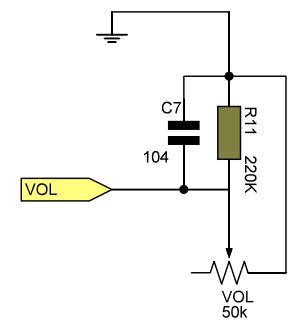
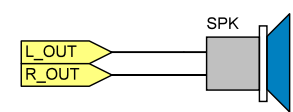
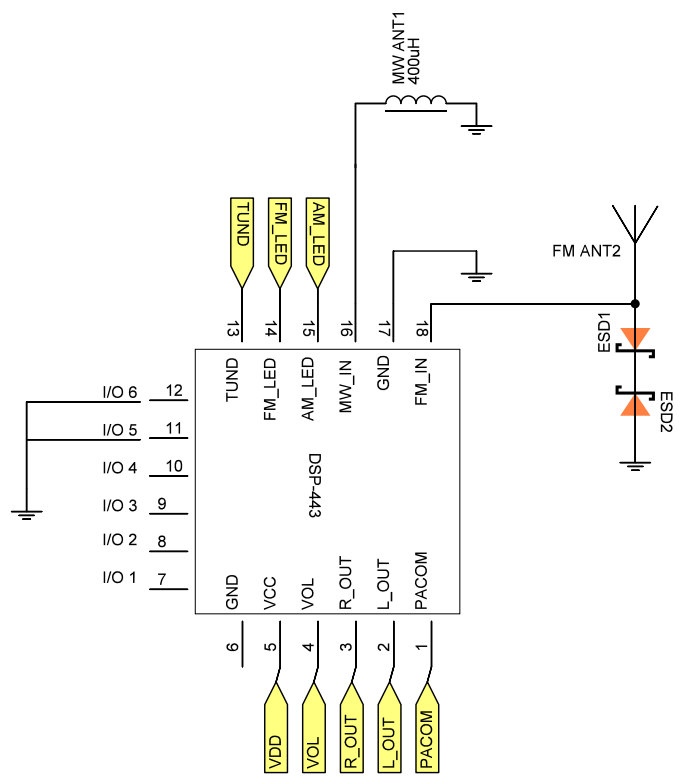

BAND SETTING		I/O					
		1	2	3	4	5	6
MW	520-1710	1	1	1	1	1	
SW1	5.95-6.2	1	1	1	0	0	
SW2	7.1-7.3	1	1	0	1		
SW3	9.5-9.9	1	1	0	0		
SW4	11.65-12.05	1	0	1	1		
SW5	13.6-13.8	1	0	1	0		
SW6	15.1-15.6	1	0	0	1		
SW7	17.5-17.9	1	0	0	0		
SW8	21.45-21.85	0	1	1	0		
FM0	87-108	x	x	x	x	1	1
FM1	70-109	x	x	x	x	0	0
FM2	56-93.5	x	x	x	x	0	1
FM3	174-223	x	x	x	x	1	0

1=VCC, 0=GND, X=open

Modifications		Date	Name	Description	Page no.
Date	Name				
					Pages
aitendo				Schematic no.	DSP-443