

MOS FIELD EFFECT TRANSISTOR 2SK679A

N-CHANNEL MOS FET FOR HIGH-SPEED SWITCHING

PACKAGE DIMENSIONS (Unit : mm)

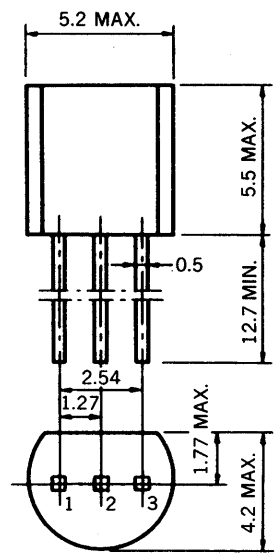

- 1. Gate (G)
- 2. Drain (D)
- 3. Source (S)

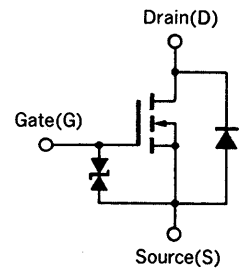

(Diode in the figure is the parasitic diode.)

The 2SK679A, N-channel vertical type MOS FET, is a switching device which can be directly driven from an IC operating with a 5 V single power supply. The device featuring low ON-state resistance is of the voltage drive type and thus is ideal for driving actuators such as motors, solenoids, and relays.

FEATURES

- Low ON-state resistance
 $R_{DS(on)} = 1.0 \Omega$ MAX. at $V_{GS} = 4.0$ V, $I_D = 0.5$ A
 $R_{DS(on)} = 0.7 \Omega$ MAX. at $V_{GS} = 10$ V, $I_D = 0.5$ A
- Voltage drive at logic level ($V_{GS} = 4$ V) is possible.
- Bidirectional zener diode for protection is incorporated in between the gate and the source.
- Inductive loads can be driven without protective circuit thanks to the improved breakdown voltage between the Drain and Source.

QUALITY GRADE

Standard

Please refer to "Quality grade on NEC Semiconductor Devices" (Document number IEI-1209) published by NEC Corporation to know the specification of quality grade on the devices and its recommended applications.

ABSOLUTE MAXIMUM RATINGS ($T_a = 25^\circ\text{C}$)

| PARAMETER | SYMBOL | RATINGS | UNIT | TEST CONDITIONS |
|-------------------------|----------------|-------------|------------------|---|
| Drain to Source Voltage | V_{DSS} | 30 | V | $V_{GS} = 0$ |
| Gate to Source Voltage | V_{GSS} | ± 20 | V | $V_{DS} = 0$ |
| Drain Current (DC) | $I_{D(DC)}$ | ± 0.5 | A | |
| Drain Current (pulse) | $I_{D(pulse)}$ | ± 1.5 | A | $PW \leq 10$ ms, Duty Cycle ≤ 50 % |
| Total Power Dissipation | P_T | 750 | mW | |
| Channel Temperature | T_{ch} | 150 | $^\circ\text{C}$ | |
| Storage Temperature | T_{stg} | -55 to +150 | $^\circ\text{C}$ | |

ELECTRICAL CHARACTERISTICS (T_a = 25 °C)

| PARAMETER | SYMBOL | MIN. | TYP. | MAX. | UNIT | TEST CONDITIONS |
|-------------------------------------|----------------------|------|------|------|------|--|
| Drain Cut-off Current | I _{DSS} | | | 10 | μA | V _{DS} = 30 V, V _{GS} = 0 |
| Gate Leakage Current | I _{GSS} | | | ±10 | μA | V _{GS} = ±20 V, V _{DS} = 0 |
| Gate Cut-off Voltage | V _{GS(off)} | 1.0 | 1.6 | 2.5 | V | V _{DS} = 10 V, I _D = 1 mA |
| Forward Transfer Admittance | Y _{fs} | 0.4 | | | S | V _{DS} = 10 V, I _D = 0.5 A |
| Drain to Source On-State Resistance | R _{DS(on)1} | | 0.6 | 1.0 | Ω | V _{GS} = 4.0 V, I _D = 0.5 A |
| Drain to Source On-State Resistance | R _{DS(on)2} | | 0.4 | 0.7 | Ω | V _{GS} = 10 V, I _D = 0.5 A |
| Input Capacitance | C _{iss} | | 130 | | pF | V _{DS} = 5.0 V, V _{GS} = 0, f = 1 MHz |
| Output Capacitance | C _{oss} | | 70 | | pF | |
| Feedback Capacitance | C _{rss} | | 30 | | pF | |
| Turn-On Delay Time | t _{d(on)} | | 12 | | ns | V _{GS(on)} = 10 V, R _G = 10 Ω V _{DD} = 25 V, I _D = 0.5 A R _L = 50 Ω |
| Rise Time | t _r | | 44 | | ns | |
| Turn-Off Delay Time | t _{d(off)} | | 310 | | ns | |
| Fall Time | t _f | | 160 | | ns | |

SWITCHING TIME MEASUREMENT CIRCUIT AND CONDITIONS

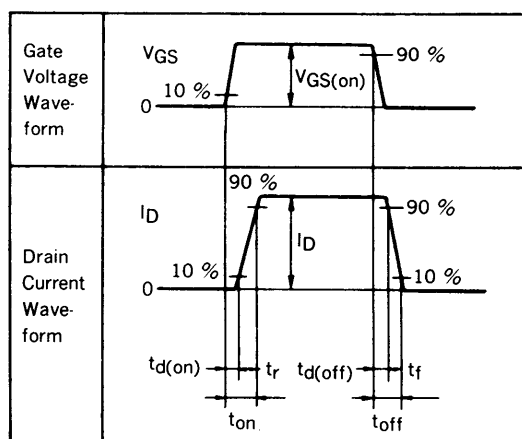
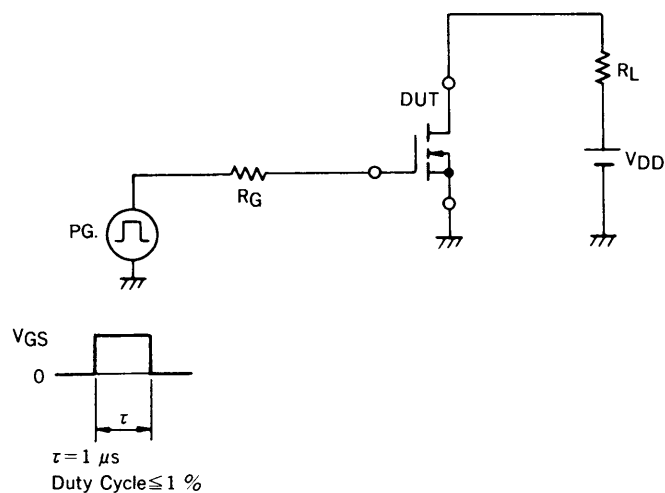

TYPICAL CHARACTERISTICS (T_a = 25 °C)

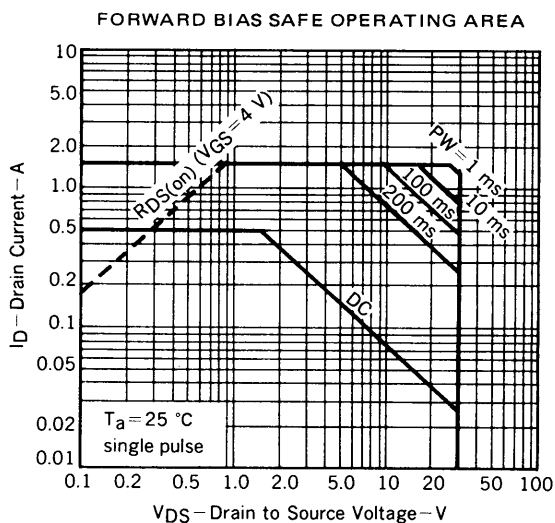
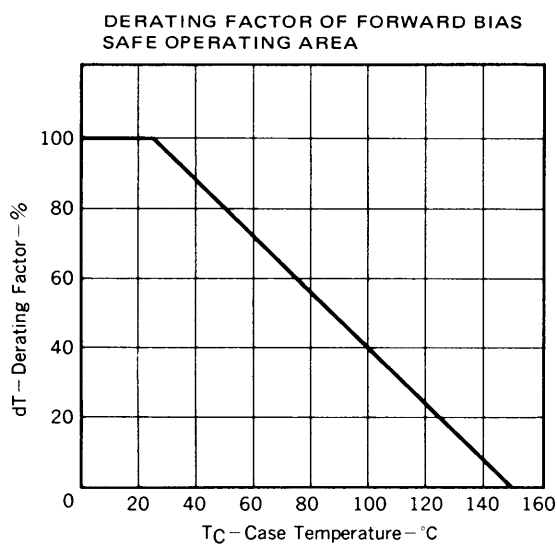

TOTAL POWER DISSIPATION vs. AMBIENT TEMPERATURE

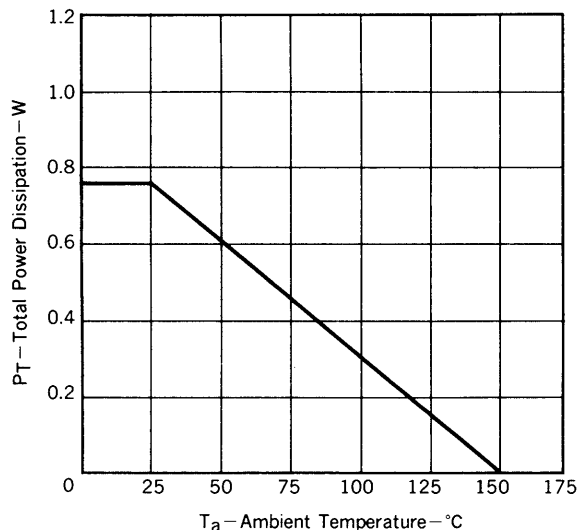

DRAIN CURRENT vs. DRAIN TO SOURCE VOLTAGE

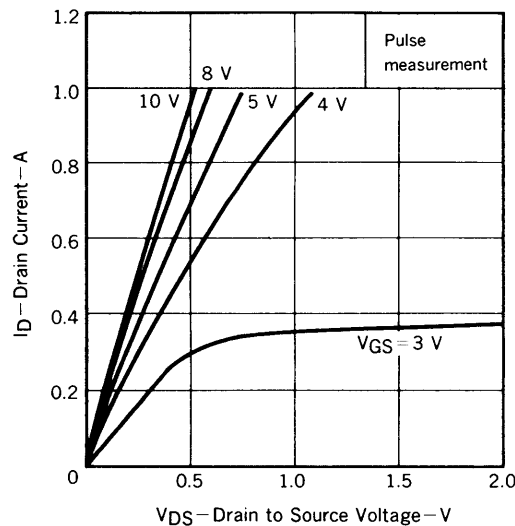

TRANSFER CHARACTERISTICS

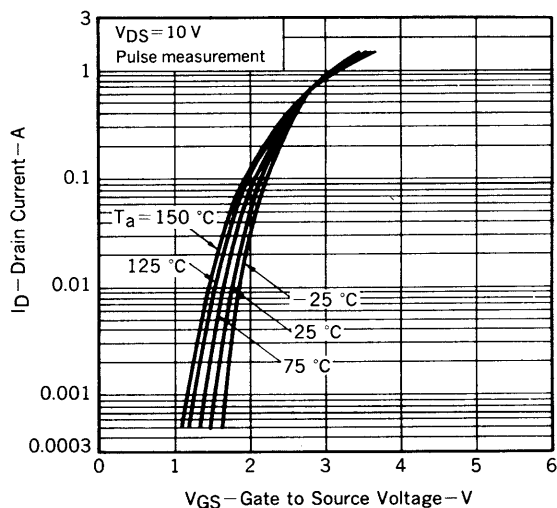

FORWARD TRANSFER ADMITTANCE vs. DRAIN CURRENT

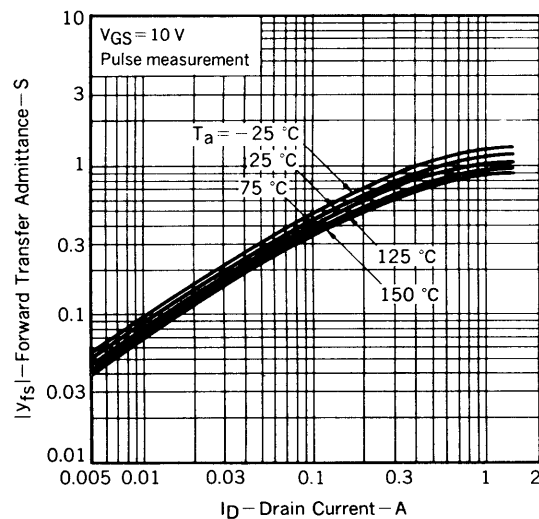

DRAIN TO SOURCE ON-STATE RESISTANCE vs. GATE TO SOURCE VOLTAGE

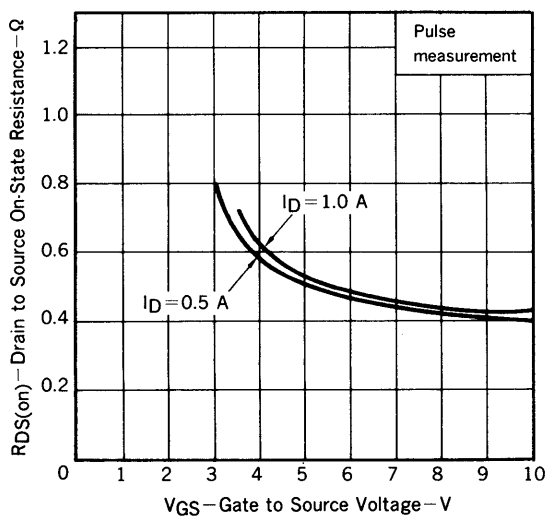

DRAIN TO SOURCE ON-STATE RESISTANCE vs. DRAIN CURRENT

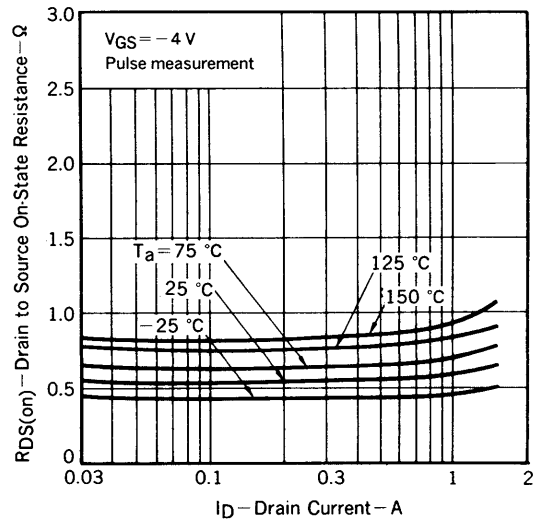

DRAIN TO SOURCE ON-STATE RESISTANCE vs. DRAIN CURRENT

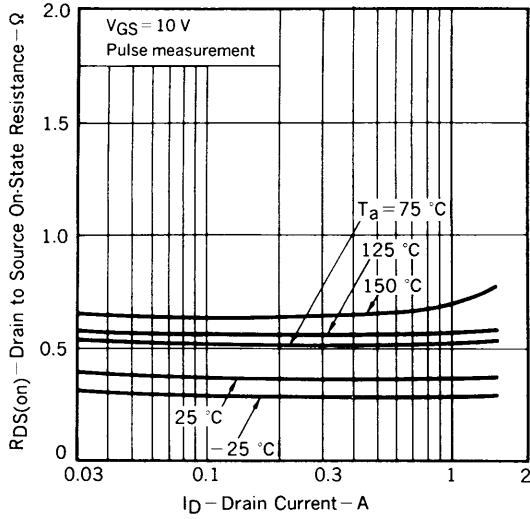

DRAIN TO SOURCE ON-STATE RESISTANCE vs. CHANNEL TEMPERATURE

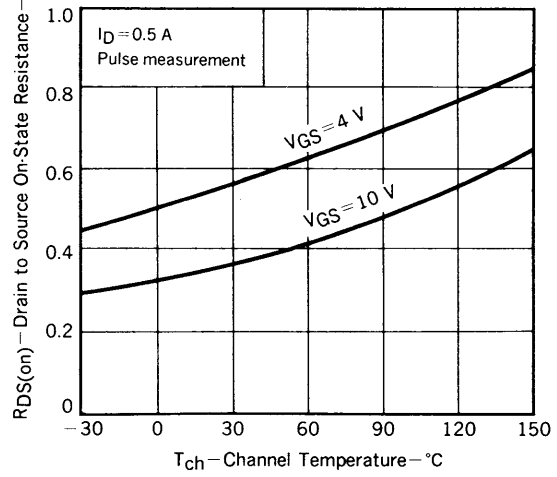

CAPACITANCE vs. DRAIN TO SOURCE VOLTAGE

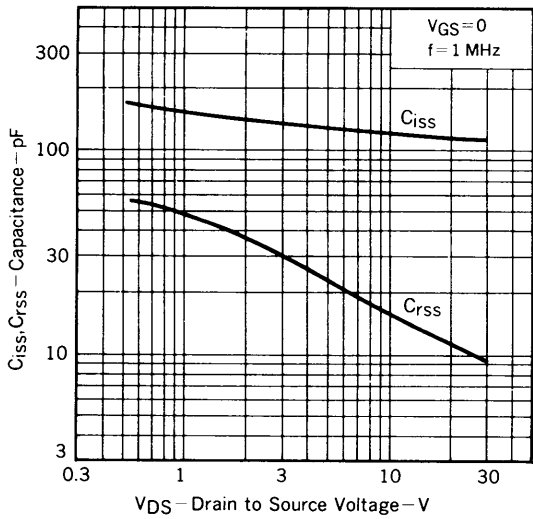

SWITCHING CHARACTERISTICS

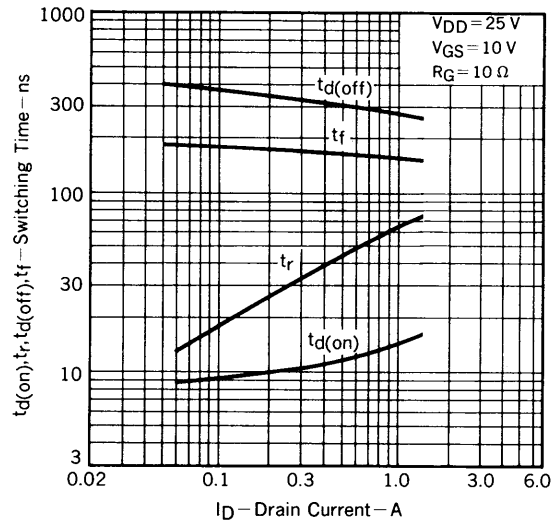

SOURCE TO DRAIN DIODE FORWARD VOLTAGE

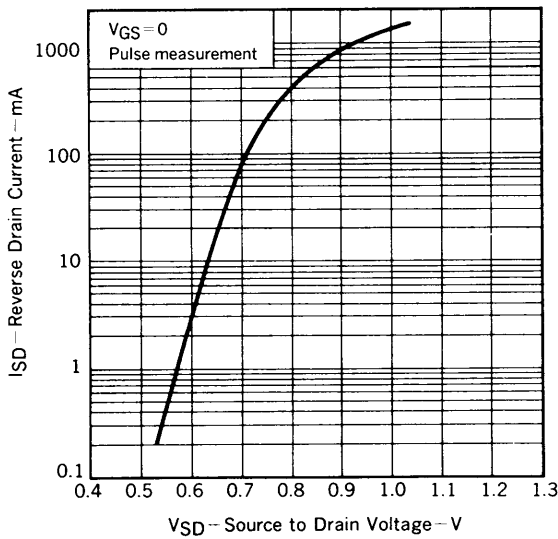

RECOMMENDED SOLDERING CONDITIONS

Solder this product under the following recommended conditions.

For soldering methods or soldering conditions other than those recommended in the table, please consult our NEC salespeople.

Insert type

| Soldering method | Soldering conditions | Recommended condition code |
|------------------|---|----------------------------|
| Wave soldering | Solder bath temperature: 260 °C max. Soldering time: 10 sec max. | |

[MEMO]

No part of this document may be copied or reproduced in any form or by any means without the prior written consent of NEC Corporation. NEC Corporation assumes no responsibility for any errors which may appear in this document.

NEC corporation does not assume any liability for infringement of patents, copyrights or other intellectual property rights of third parties by or arising from use of a device described herein or any other liability arising from use of such device. No license, either express, implied or otherwise, is granted under any patents, copyrights or other intellectual property rights of NEC Corporation or others.

The devices listed in this document are not suitable for use in the field where very high reliability is required including, but not limited to, aerospace equipment, submarine cables, nuclear reactor control systems and life support systems. If customers intend to use NEC devices for above applications or those intended to use "Standard", or "Special" quality grade NEC devices for the applications not intended by NEC, please contact our sales people in advance.

Application examples recommended by NEC Corporation

Standard: Data processing and office equipment, Communication equipment (terminal, mobile). Test and Measurement equipment, Audio and Video equipment, Other consumer products, etc.

Special: Automotive and Transportation equipment, Communication equipment (trunk line), Train and Traffic control devices, industrial robots, Burning control systems, antidisaster systems, anticrime systems etc.