

# GBPC1005 THRU GBPC110

## GLASS PASSIVATED SINGLE-PHASE BRIDGE RECTIFIER

Reverse Voltage - 50 to 1000 Volts Forward Current - 3.0 Amperes

### Case Style GBPC1

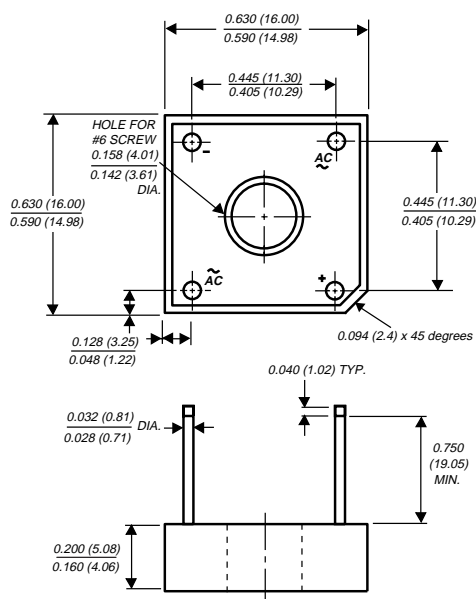

Polarity shown on side of case: Positive lead by beveled corner

Dimensions in inches and (millimeters)

### FEATURES

- ◆ Plastic package has Underwriters Laboratory Flammability Classification 94V-0
- ◆ This series is UL listed under Recognized Component Index, file number E54214
- ◆ Glass passivated chip junctions
- ◆ High case dielectric with standing voltage of 1500 VRMS
- ◆ Typical IR less than 0.1μA
- ◆ High surge current capability
- ◆ Ideal for printed circuit boards
- ◆ High temperature soldering guaranteed: 260°C/10 seconds, 0.375" (9.5mm) lead length, 5lbs. (2.3kg) tension

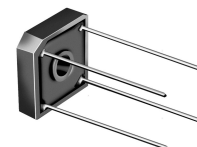

### MECHANICAL DATA

**Case:** Molded plastic body over passivated junctions  
**Terminals:** Plated leads solderable per MIL-STD-750, Method 2026  
**Mounting Position:** Any (NOTE 1)  
**Mounting Torque:** 5.0 in. - lb. max.  
**Weight:** 0.1 ounce, 2.8 grams

## MAXIMUM RATINGS AND ELECTRICAL CHARACTERISTICS

Ratings at 25°C ambient temperature unless otherwise specified.

	SYMBOLS	GBPC 1005	GBPC 101	GBPC 102	GBPC 104	GBPC 106	GBPC 108	GBPC 110	UNITS	
Maximum repetitive peak reverse voltage	VRRM	50	100	200	400	600	800	1000	Volts	
Maximum RMS bridge input voltage	VRMS	35	70	140	280	420	560	700	Volts	
Maximum DC blocking voltage	VDC	50	100	200	400	600	800	1000	Volts	
Maximum average forward rectified output current at TC=60°C (NOTE 2) TA=25°C (NOTE 3)	I(AV)	3.0				2.0				Amps
Peak forward surge current single sine-wave superimposed on rated load (JEDEC Method) TC=60°C	IFSM	60.0								Amps
Rating for fusing (t<8.3ms)	I²t	15.0								A²sec
Maximum instantaneous forward voltage drop per leg at 1.5 Amperes	VF	1.0								Volts
Maximum DC reverse current at rated DC blocking voltage per leg TA= 25°C TA=125°C	IR	5.0				500.0				μA
Typical junction capacitance per leg (NOTE 4)	CJ	21.0								pF
Typical thermal resistance per leg (NOTE 2)	RθJA RθJC	12.0				8.0				°C/W
Operating junction and storage temperature range	TJ, TSTG	-55 to +150								°C

#### NOTES:

- (1) Bolt down on heat-sink with silicone thermal compound between bridge and mounting surface for maximum heat transfer with #6 screw
- (2) Unit mounted on 4.0 x 4.0 x 0.11" thick (10.5 x 10.5 x 0.3cm) Al. Plate
- (3) Unit mounted on P.C.B. at 0.375" (9.5mm) lead length with 0.5 x 0.5" (12 x 12mm) copper pads
- (4) Measured at 1.0 MHz and applied reverse voltage of 4.0 Volts

# RATINGS AND CHARACTERISTICS CURVES GBPC1005 THRU GBPC110

**FIG. 1 - DERATING CURVE OUTPUT RECTIFIED CURRENT**

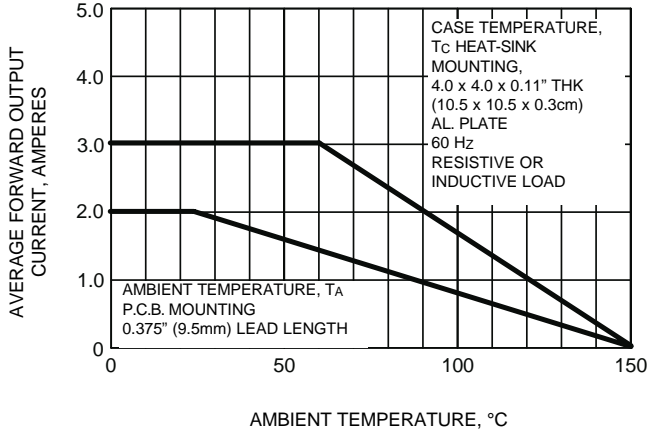

**FIG. 2 - MAXIMUM NON-REPETITIVE PEAK FORWARD SURGE CURRENT PER LEG**

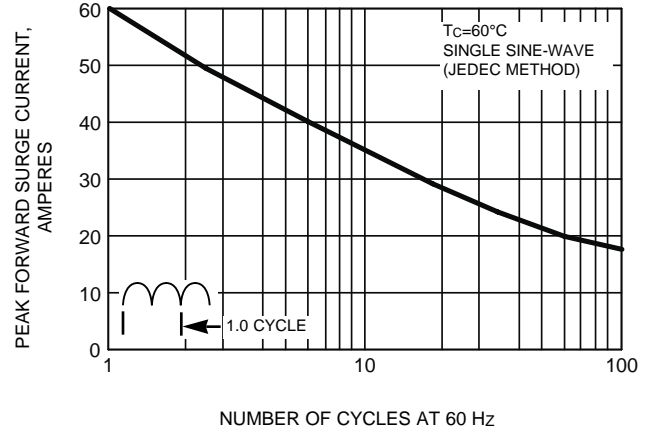

**FIG. 3 - TYPICAL FORWARD CHARACTERISTICS PER LEG**

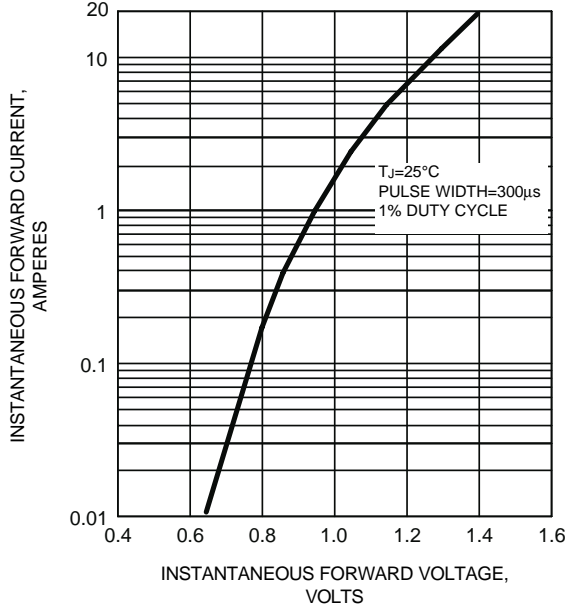

**FIG. 4 - TYPICAL REVERSE LEAKAGE CHARACTERISTICS PER LEG**

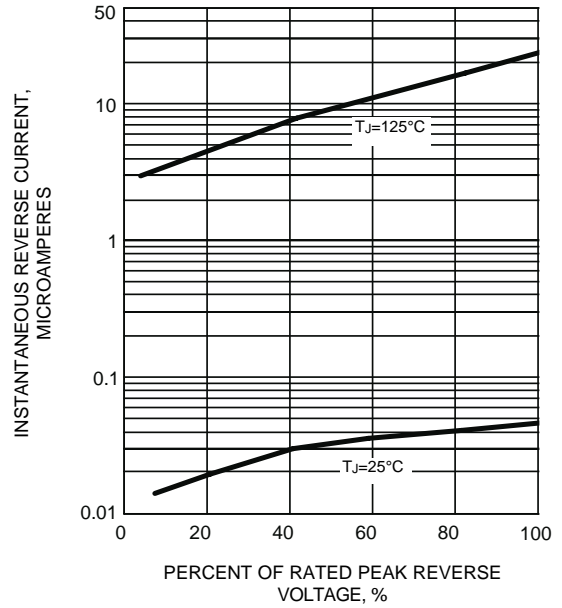

**FIG. 5 - TYPICAL JUNCTION CAPACITANCE PER LEG**

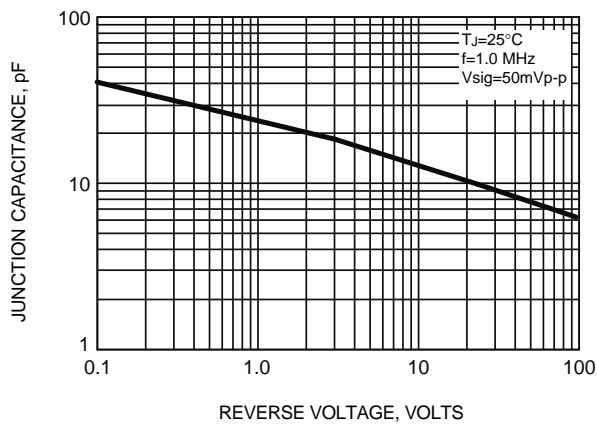

**FIG. 6 - TYPICAL TRANSIENT THERMAL IMPEDANCE PER LEG**

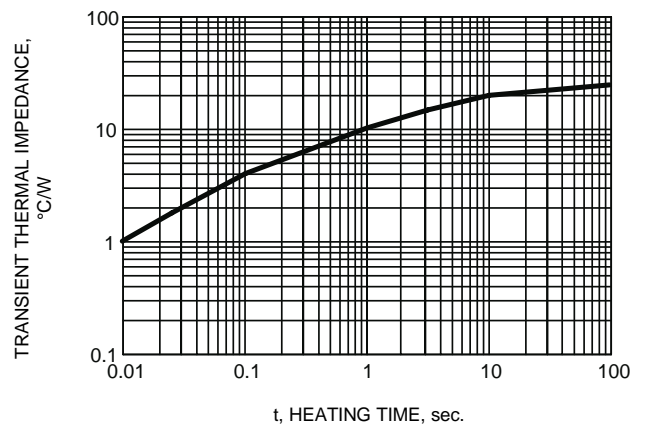

This datasheet has been download from:

[www.datasheetcatalog.com](http://www.datasheetcatalog.com)

Datasheets for electronics components.