

Date: 2022/03/05

Specifications for Approval

Model name : 1602A-13 REV:A

ENG	QA	APPROVAL
Andy	Leo	Duke

Customer Approval	<input type="checkbox"/> Accept <input type="checkbox"/> Reject Comment: Approved by:
--------------------------	--

REVISION RECORD

Revision	Revision Date	Page	Contents
A	2022/03/05		Initial Release and Issue Full Specification

CONTENTS

1. FEATURES

The features of LCD are as follows

- * Display mode : STN /BLUE, NEGATIVE, TRANSMISSIVE
- * Color : Display dot :WHITE
Background: BLUE
- * Display Format : 16(characters) × 2(line)
- * IC : 7066 7065
- * Interface Input Data : 8 位
- * Driving Method : 1/16 Duty, 1/4 Bias
- * Viewing Direction : 6 O'clock
- * Backlight : LED(WHITE)

2. MECHANICAL SPECIFICATIONS

Item	Specification	Unit
Module Size	80.00(W) X36.00(H) X11.1(T)	mm
Viewing Area	64.50(W) X 14.50(H)	mm
Effective Display Area	55.70(W) X 11.00(H)	mm
Number of Dots	16(characters) × 2(line)	-
Dot Size	0.54(W) X 0.60(H)	mm
Dot Pitch	0.59(W) X0.65(H)	mm

3. ELECTRICAL SPECIFICATIONS

3-1. Absolute Maximum Ratings (V_{SS}=0V)

Item	Symbol	Standard Value			Unit
		Min.	Typ.	Max.	
Supply Voltage For Logic	V _{DD}	-0.3	-	5.0	V
Supply Voltage For LCD Drive	V ₀ , V _{OUT}	-0.3	-	14.5	V
Operating Temp.	T _{OP}	-20	-	+70	°C
Storage Temp.	T _{ST}	-30	-	+80	°C
Static Electricity	Be sure that you are ground when handing LCM				

3. ELECTRICAL SPECIFICATIONS

3-2-1. Electrical Characteristics

Item	Symbol	Test Condition	Min.	Typ.	Max.	Unit
Supply Voltage For Logic	$V_{DD} - V_{SS}$	$T_a=25^{\circ}C$	4.8	5.0	5.2	V
Supply Voltage For LCD	$V_{DD} - V_0$	$T_a=25^{\circ}C$	4.5	4.7	4.9	V
Input Voltage	"H" Level	$T_a=25^{\circ}C$	$0.8V_{DD}$	-	V_{DD}	V
	"L" Level		V_{SS}	-	$0.2V_{DD}$	V
Output Voltage	"H" Level	$I_{OUT} = -0.5mA$	$0.8V_{DD}$	-	V_{DD}	V
	"L" Level	$I_{OUT} = 0.5mA$	V_{SS}	-	$0.2V_{DD}$	V
Current Consumption	I_{DD}	$V_{IN} = V_{DD}$	-	-	1.0	mA

NOTE: 1) Duty ratio=1/65, Bias=1/9

2) Measured in Dots ON-state

3-3. BACKLIGHT

3-3-1. Absolute Maximum Ratings

Item	Symbol	Condition	Min.	Typ.	Max	Unit
Forward Current	I_F	$T_a= 25^{\circ}C$	-	-	20	mA
Reverse Voltage	V_R		-	-	5	V
Power Dissipation	P_D	$T_a= 25^{\circ}C$	-	-	100	mW

3-3-2. Opto-electronic Characteristics

Item	Symbol	Condition	Min.	Typ.	Max	Unit
Forward Voltage	V_F	$T_a= 25^{\circ}C$ $I_F= 32mA$	4.8	5.0	5.2	V
Luminous	-		100	150	-	cd/m ²

* The brightness is measured without LCD panel

4. schematic diagram

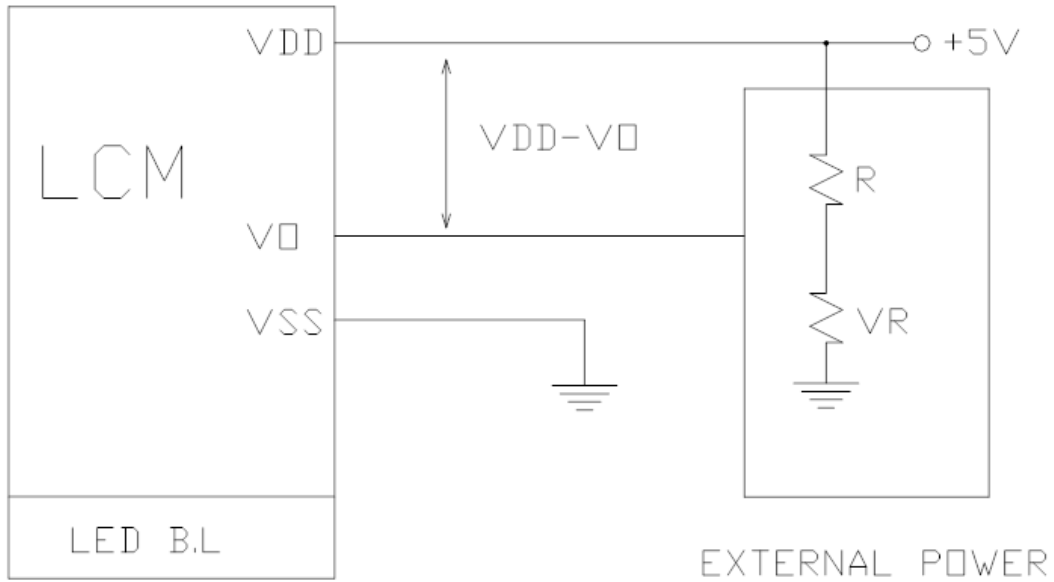
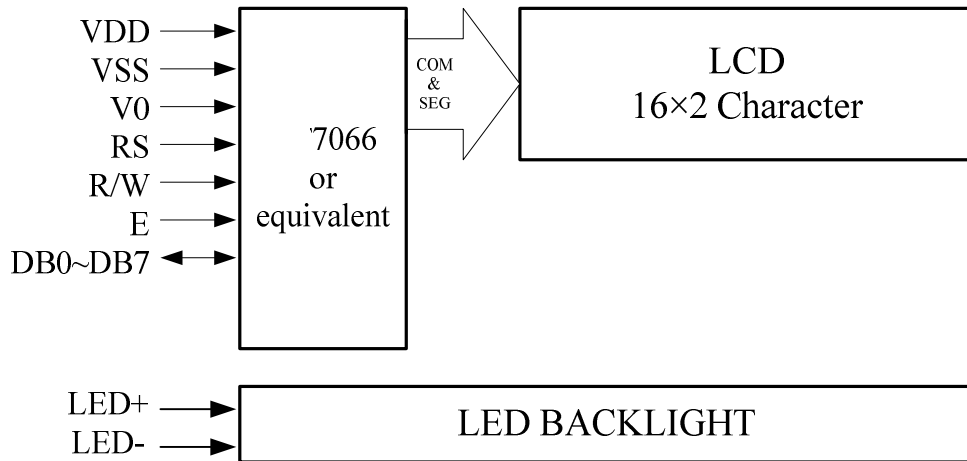

$V_{DD} - V_0$: LCD DRIVING VOLTAGE

V_R : 10K ~ 20K

IF $V_0(LCD) > 5.0V$, THE EXTERNAL POWER MUST BE USED

5. Interface Pin Function

Pin No.	Pin Out	Description
1	VSS	GND
2	VDD	Logic supply voltage (5.0V)
3	VO	Power supply for LCD
4	RS	Data/Instruction RS=high: Indicates that data of DB0~DB7 is display data. RS=low: Indicates that data of DB0~DB7 is instruction
5	R/W	Read/Write R/W=high: Data of DB0~DB7 can be read by CPU. R/W=low: Data of DB0~DB7 can be written into LCD driver IC..
6	E	Enable When write(R/W=low): Data of DB0~DB7 is latched at the fall of E When read(R/W=high): Data is read while E is at high level.
7	DB0	Data Bus line.
8	DB1	
9	DB2	
10	DB3	
11	DB4	
12	DB5	
13	DB6	
14	DB7	
15	A	LED Backlight +.
16	K	LED Backlight -.

6. COMMAND LIST

Instruction Table:

Instruction	Instruction Code										Description	Description Time (270KHz)	
	RS	R/W	DB7	DB6	DB5	DB4	DB3	DB2	DB1	DB0			
Clear Display	0	0	0	0	0	0	0	0	0	0	1	Write "20H" to DDRAM. and set DDRAM address to "00H" from AC	1.52 ms
Return Home	0	0	0	0	0	0	0	0	0	1	x	Set DDRAM address to "00H" from AC and return cursor to its original position if shifted. The contents of DDRAM are not changed.	1.52 ms
Entry Mode Set	0	0	0	0	0	0	0	0	1	I/D	S	Sets cursor move direction and specifies display shift. These operations are performed during data write and read.	37 us
Display ON/OFF	0	0	0	0	0	0	0	1	D	C	B	D=1:entire display on C=1:cursor on B=1:cursor position on	37 us
Cursor or Display Shift	0	0	0	0	0	0	1	S/C	R/L	x	x	Set cursor moving and display shift control bit, and the direction, without changing DDRAM data.	37 us
Function Set	0	0	0	0	0	1	DL	N	F	x	x	DL:interface data is 8/4 bits N:number of line is 2/1 F:font size is 5x11/5x8	37 us
Set CGRAM address	0	0	0	1	AC5	AC4	AC3	AC2	AC1	AC0		Set CGRAM address in address counter	37 us
Set DDRAM address	0	0	1	AC6	AC5	AC4	AC3	AC2	AC1	AC0		Set DDRAM address in address counter	37 us
Read Busy flag and address	0	1	BF	AC6	AC5	AC4	AC3	AC2	AC1	AC0		Whether during internal operation or not can be known by reading BF. The contents of address counter can also be read.	0 us
Write data to RAM	1	0	D7	D6	D5	D4	D3	D2	D1	D0		Write data into internal RAM (DDRAM/CGRAM)	37 us
Read data from RAM	1	1	D7	D6	D5	D4	D3	D2	D1	D0		Read data from internal RAM (DDRAM/CGRAM)	37 us

Note:

Be sure the ST7066U is not in the busy state (BF = 0) before sending an instruction from the MPU to the ST7066U. If an instruction is sent without checking the busy flag, the time between the first instruction and next instruction will take much longer than the instruction time itself. Refer to Instruction Table for the list of each instruction execution time.

7. TIMING CHARACTERISTICS (Continued)

AC Characteristics (VDD = 2.7 V ~ 4.5 V, Ta = -30 ~ +85°C)

Mode	Characteristics	Symbol	Min	Typ	Max	Unit
Interface Mode With Extension Driver (Refer to Fig-8)	Clock Pulse Width (High,Low)	Tc	500	-	-	ns
	Clock Rise / Fall Time	Tr,Tf	-	-	20	
	Clock Setup Time	Tsu1	500	-	-	
	Data Setup Time	Tsu2	300	-	-	
	Data Hold Time	Tdh	300	-	-	
	M Delay Time	TDM	-1000	-	1000	

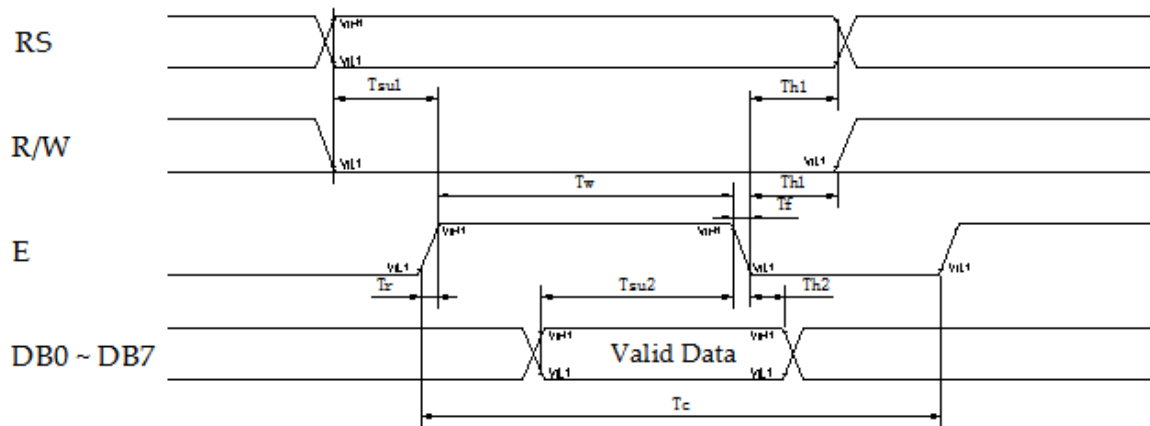

Figure 6. Write Mode Timing Diagram

8. QUALITY SPECIFICATION (Continued)

8-3. Sampling Plan and Acceptance

1. Sampling Plan

MIL - STD - 105E (||) ordinary single inspection is used.

2. Acceptance

Major defect: AQL = 0.25%

Minor defect: AQL = 0.65%

8-4. Criteria

1. COB

Defect	Inspection Item	Inspection Standards	
Major	PCB copper flakes peeling off	Any copper flake in viewing Area should be greater than 1.0mm ²	Reject
Major	Height of coating epoxy	Exceed the dimension of drawing	Reject
Major	Void or hole of coating epoxy	Expose bonding wire or IC	Reject
Major	PCB cutting defect	Exceed the dimension of drawing	Reject

2. SMT

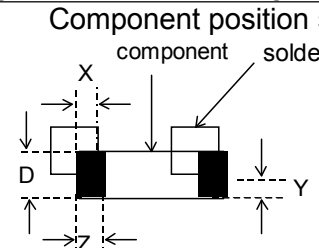
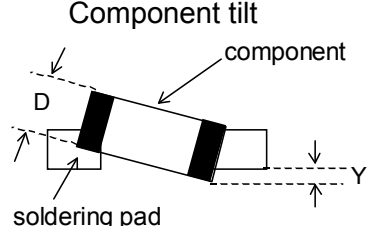
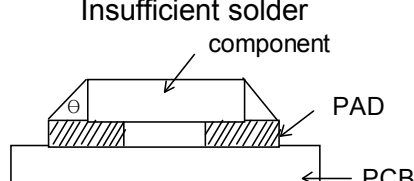
Defect	Inspection Item	Inspection Standards	
Minor	Component marking not readable		Reject
Minor	Component height	Exceed the dimension Of drawing	Reject
Major	Component solder defect (missing , extra, wrong component or wrong orientation)		Reject
Minor	<p>Component position shift</p> 	$X < 3/4Z$ $Y > 1/3D$	Reject Reject
Minor	<p>Component tilt</p> 	$Y > 1/3D$	Reject
Minor	<p>Insufficient solder</p> 	$\theta \leq 20^\circ$	Reject

8. QUALITY SECIFICATION (Continued)

8-4. Criteria (Continued)

3. Metal (Plastic) Frame

Defect	Inspection Item	Inspection Standards		
Major	Crack / breakage	Anywhere		Reject
Minor	Frame Scratch	W	L	Acceptable of Scratch
		$w < 0.03\text{mm}$	Any	Ignore
		$0.03\text{mm} \leq w < 0.05\text{mm}$	$L \leq 5.0\text{mm}$	2
		$0.05\text{mm} \leq w < 0.1\text{mm}$	$L \leq 3.0\text{mm}$	1
		$w \geq 0.1\text{mm}$	Any	0
Note: 1. Above criteria applicable to scratch lines with distance greater than 5mm. 2. Scratch on the back side of frame (not visible) can be ignored.				
Minor	Frame Dent, Prick $\Phi = \frac{L + W}{2}$			Acceptable of Dents / Pricks
		$\Phi \leq 1.0\text{mm}$		2
		$1.0 < \Phi \leq 1.5\text{mm}$		1
		$1.5\text{mm} > \Phi$		0
Note: 1. Above criteria applicable to any two dents / pricks with distance greater than 5mm 2. Dent / prick on the back side of frame (not visible) can be ignored				
Minor	Frame Deformation	Exceed the dimension of drawing		
Minor	Metal Frame Oxidation	Any rust		

4. Flexible Film Connector (FFC)

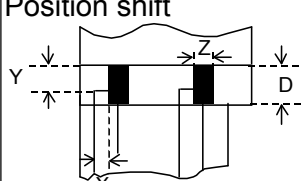
Defect	Inspection Item	Inspection Standards	
Minor	Tilted soldering	Within the angle $\pm 3^\circ$	Acceptable
Minor	Uneven solder joint /bump		Reject
Minor	Hole $\Phi = \frac{L + W}{2}$	Expose the conductive line	Reject
		$\Phi > 1.0\text{mm}$	Reject
Minor	Position shift 	$Y > 1/3D$	Reject
		$X > 1/2Z$	Reject

8. QUALITY SPECIFICATION (Continued)

8-4. Criteria (Continued)

5. Screw

Defect	Inspection Item	Inspection Standards	
Major	Screw missing/loosen		Reject
Minor	Screw oxidation	Any rust	Reject
Minor	Screw deformation	Difficult to accept screw driver	Reject

6. Heat seal 、TCP 、FPC

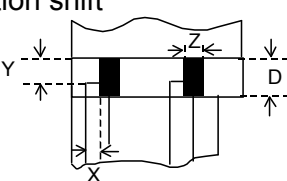
Defect	Inspection Item	Inspection Standards	
Major	Scratch expose conductive layer		Reject
Minor	HS Hole $\Phi = \frac{L+W}{2}$	$\Phi > 0.2\text{mm}$	Reject
Major	Adhesion strength	Less than the specification	Reject
Minor	Position shift 	$Y > 1/3D$	Reject
		$X > 1/2Z$	Reject
Major	Conductive line break		Reject

7. LED Backing Protective Film and Others

Defect	Inspection Item	Inspection Standards	
Minor	LED dirty, prick	Acceptable number of units	
		$\Phi \leq 0.10\text{mm}$	Ignore
		$0.10 < \Phi \leq 0.15\text{mm}$	2
		$0.15 < \Phi \leq 0.2\text{mm}$	1
		$\Phi > 0.2\text{mm}$	0
		The distance between any two spots should be $\geq 10\text{mm}$ Any spot/dot/void outside of viewing area is acceptable	
Minor	Protective film tilt	Not fully cover LCD	Reject
Major	COG coating	Not fully cover ITO circuit	Reject

8. Electric Inspection

Defect	Inspection Item	Inspection Standards	
Major	Short		Reject
Major	Open		Reject

8. QUALITY SPECIFICATION (Continued)

8-4. Criteria (Continued)

9. Inspection Specification of LCD

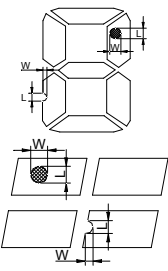
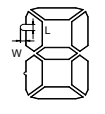
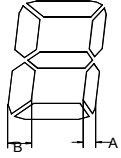
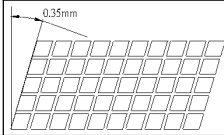
Defect	Inspect Item	Inspection Standards				
		W	$W \leq 0.03$	$0.03 < W \leq 0.05$	$W > 0.05$	
Minor	Linear Defect * Glass Scratch * Polarizer Scratch * Fiber and Linear material	L	$L < 5$	$L < 3$	Any	
		ACC. NO.	1	1	Reject	
		Note	L is the length and W is the width of the defect			
Minor	Black Spot and Polarizer Pricked * Foreign material between glass and polarizer or glass and glass * Polarizer hole or protuberance by external force	Φ	$\Phi \leq 0.1$	$0.1 < \Phi \leq 0.15$	$0.15 < \Phi \leq 0.2$	$\Phi > 0.2$
		ACC. NO.	3EA / 1PC	2	1	0
		Note	Φ is the average diameter of the defect. Distance between two defects > 10mm.			
Minor	White Spot and Bubble in polarizer * Unobvious transparent foreign material between glass and glass or glass and polarizer * Air protuberance between polarizer and glass	Φ	$\Phi \leq 0.1$	$0.1 < \Phi \leq 0.15$	$0.15 < \Phi \leq 0.2$	$\Phi > 0.2$
		ACC. NO.	3EA / 1PC	2	1	0
		Note	Φ is the average diameter of the defect. Distance between two defects > 10mm.			
Minor	Segment Defect 	Φ	$\Phi \leq 0.10$	$0.10 < \Phi \leq 0.20$	$\Phi > 0.2$	
		ACC. NO.	3EA / 1PC	2	0	
		Note	W is more than 1/2 segment width		Reject	
			$\Phi = \frac{L + W}{2}$ Distance between two defect is 10mm			
Minor	Protuberant Segment  $\Phi = (L + W) / 2$	Φ	$\Phi \leq 0.10$	$0.10 < \Phi \leq 0.20$	$\Phi > 0.2$	
		W	Glue	$W \leq 1/2$ Seg, $W \leq 0.2$	Ignore	
		ACC. NO.	3EA / 1PC	2	0	
Minor	Assembly Mis-alignment  	1. Segment				
		B	$B \leq 0.4\text{mm}$	$0.4 < B \leq 1.0\text{mm}$	$B > 1.0\text{mm}$	
		B-A	$B-A < 1/2B$	$B-A < 0.2$	$B-A < 0.25$	
		Judge	Acceptable	Acceptable	Acceptable	
		2. Dot Matrix				
		Deformation > 0.35mm			Reject	
Minor	Stain on LCD Panel Surface	Accept when stains can be wiped lightly with a soft cloth or a similar one. Otherwise, judged according to the above items: "Black spot" and "White Spot"				

9. RELIABILITY

NO.	Item	Condition	Criterion
1	High Temperature Operating	70°C, 96Hrs	No defect in cosmetic and operational function allowable.
2	Low Temperature Operating	-20°C, 96Hrs	
3	High Humidity	40°C, 90%RH, 96Hrs	
4	High Temperature Storage	80°C, 96Hrs	
5	Low Temperature Storage	-30°C, 96Hrs	
6	Vibration	Random wave 10 ~ 100Hz Acceleration: 2g 2 Hrs per direction(X,Y,Z)	Total current Consumption should be below double of initial value.
7	Thermal Shock	-10°C to 25°C to 60°C (60Min) (5Min) (60Min) 16Cycles	
8	ESD Testing	Contract Discharge Voltage: +1 ~ 5kV and -1 ~ -5kV	There will be discharged ten times at every discharging voltage cycle. The voltage gap is 1kV.
		Air Discharge Voltage: +1 ~ 8kV and -1 ~ -8kV	

- Note:
- 1) Above conditions are suitable for xinnuoya standard products.
 - 2) For restrict products, the test conditions listed as above must be revised.

10. HANDLING PRECAUTION

(1) Mounting Method

The panel of the LCD Module consists of two thin glass plates with polarizers which easily get damaged since the Module is fixed by utilizing fitting holes in the printed circuit board. Extreme care should be taken when handling the LCD Modules.

(2) Caution of LCD handling & cleaning

When cleaning the display surface, use soft cloth with solvent (recommended below) and wipe lightly.

- Isopropyl alcohol
- Ethyl alcohol
- Trichlorotrifluoroethane

Do not wipe the display surface with dry or hard materials that will damage the polarizer surface.

Do not use the following solvent:

- Water
- Ketone
- Aromatics

(3) Caution against static charge

The LCD Module use C-MOS LSI drivers, so we recommend that you connect any unused input terminal to VDD or VSS, do not input any signals before power is turned on. And ground your body, Work/assembly table. And assembly equipment to protect against static electricity.

(4) Packaging

- Modules use LCD elements, and must be treated as such. Avoid intense shock and falls from a height.
- To prevent modules from degradation. Do not operate or store them exposed directly to sunshine or high temperature/humidity.

(5) Caution for operation

- It is indispensable to drive LCD's within the specified voltage limit since the higher voltage than the limit shorten LCD life. An electrochemical reaction due to direct current causes LCD deterioration, Avoid the use of direct current drive.

10. HANDLING PRECAUTION (Continued)

- Response time will be extremely delayed at lower temperature than the operating temperature range and on the other hand at higher temperature LCD's show dark color in them.

However those phenomena do not mean malfunction or out of order with LCD's.

Which will come back in the specified operating temperature range.

- If the display area is pushed hard during operation, some font will be abnormally displayed but it resumes normal condition after turning off once.
- A slight dew depositing on terminals is a cause for electro-chemical reaction resulting in terminal open circuit.

Usage under the relative condition of 60 C, 90%RH or less is required.

(6) Storage

In the case of storing for a long period of time (for instance ,for years) for the purpose or replacement use, The following ways are recommended.

- Storage in a polyethylene bag with sealed so as not to enter fresh air outside in it, And with no desiccant.
- Placing in a dark place where neither exposure to direct sunlight nor light is. Keeping temperature in the specified storage temperature range.
- Storing with no touch on polarizer surface by the anything else. (It is recommended to store them as they have been contained in the inner container at the time of delivery)

(7) Safety

- It is recommendable to crash damaged or unnecessary LCD into pieces and wash off liquid crystal by using solvents such as acetone and ethanol.

Which should be burned up later.

- When any liquid crystal leaked out of a damaged glass cell comes in contact with your hands, please wash it off well with soap and water.

11. OUTLINE DIMENTION

CUSTOMER APPROVED:

日期

版本

修改内容

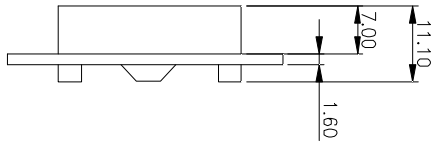
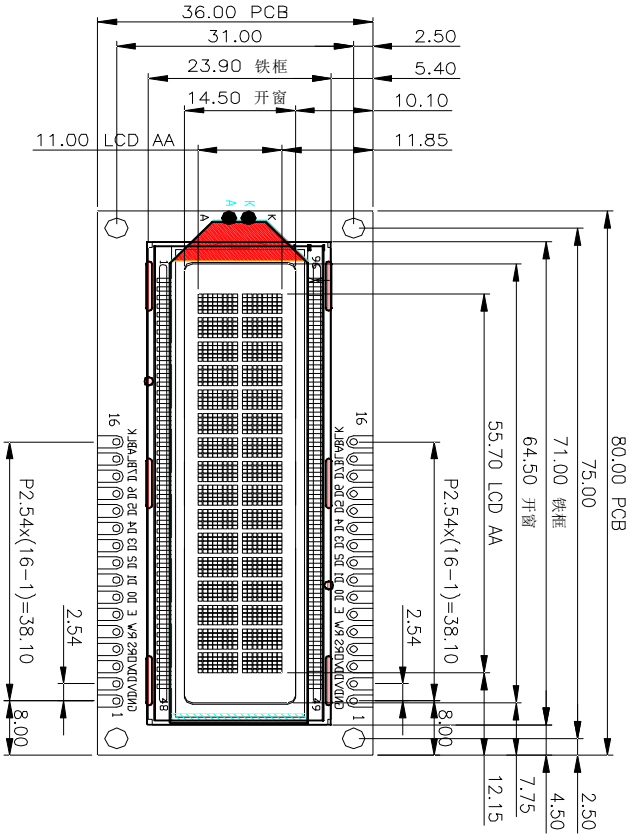

1	GND
2	VDD
3	V0
4	RS
5	R/W
6	E
7	DB0
8	DB1
9	DB2
10	DB3
11	DB4
12	DB5
13	DB6
14	DB7
15	BLA
16	BLK

- SPECIFICATION:
- 1). STN(BLUE)/NEGATIVE/TRANSMISSIVE
 - 2). DUTY:1/16. BIAS:1/4. VO/VOUT
 - 3). VIEWING ANGLE: 6 0' CLOCK
 - 4). DRIVE VOLTAGE: 5.0V
 - 5). OPERATING TEMPERATURE: -20~70°C
 - 6). BACKLIGHT: WHITE IF=20MA
 - 7). DRIVE IC: 7066, 7065

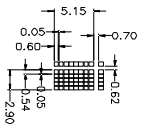

3.0V±0.2V 15MA 白色

UNIT : mm		DATE: 20220305	REV: A	UNDEFINED TOLERANCE: ±0.3
DRAWN: LU0		Product: 1602A-13	CHECKED: OSCAR	Dwg.
				PAGE: 1/1