

Sync. Rectifier Step Up Converter

Features

- Up to 90% Efficiency at $I_{OUT}=2A$ $V_{OUT} = 5V$ from 3.3V Input
- Low 110 μ A Quiescent Current
- Guaranteed 3A Output Current at $V_{OUT} = 5V$ from 3.3V Input
- 500KHz PWM Switching Frequency
- Synchronous and Embedded Power Mosfets; No Schottky Diode Required
- Internal Soft-Start to Limit Inrush Current
- Adjustable Output
- Output turn off true shutdown function
- Current Mode Operation with Internal Compensation for Excellent Line and Load Transient Response
- Overload/Short-Circuit Protection with hiccup control
- Shutdown Current <1 μ A
- Thermal Shutdown
- Compact 8 pin, SOP8 (FD) package

General Description

The G5177C is a compact, high-efficiency, synchronous step-up converter with power Mosfets embedded and with output turn off true shutdown function and adjustable output current limiting with foldback for a single-cell Li-ion/polymer battery. The G5177C uses only 110 μ A (typ) quiescent current and allows the converter to switch only when needed at no load and light loads, and when load is higher than 100mA, it uses fixed-frequency PWM technique at 500KHz. It features a current mode control for fast transient response with internal compensation. The G5177C includes cycle-by-cycle current limit to maximum inductor current and over-temperature protection circuit. The G5177C is suitable for iPad-like computers, smart phones and portable handheld devices.

The G5177C is available in a SOP8 (FD) package. The operating temperature range is from -20°C to +85°C.

Application

- iPad-like computers, smart phones and portable handheld devices.

Ordering Information

ORDER NUMBER	MARKING	TEMP. RANGE	PACKAGE (Green)
G5177CF11U	G5177C	-20°C to +85°C	SOP-8 (FD)

Note: F1:SOP-8 (FD)

1: Bonding Code

U: Tape & Reel

Green : Lead Free / Halogen Free

Pin Configuration

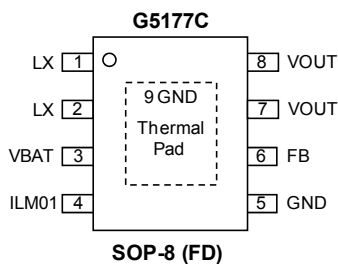

Note: Recommend connecting the Thermal Pad to the Ground for excellent power dissipation.

Typical Application Circuit

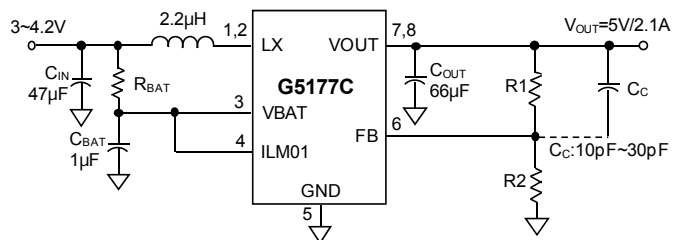

$V_{OUT} = V_{REF} * (1 + R1/R2)$, where V_{REF} typical is 1.23V.
 R_{bat} may be varied in different application requirement.

Absolute Maximum Ratings

VOUT to GND	-0.3V to 6V
LX to GND	-0.3V to 6V
ILIM0 to GND	-0.3V to 6V
ILIM1 to GND	-0.3V to 6V
FB to GND	-0.3V to 6V
BAT to GND	-0.3V to 6V
Thermal Resistance of Junction to Ambient (θ_{JA})	
SOP-8 (FD)	132°C/W ⁽¹⁾
SOP-8 (FD) (1in ²)	108°C/W ⁽²⁾

Continuous Power Dissipation ($T_A = +25^\circ\text{C}$)	
SOP-8 (FD)	0.9W ⁽¹⁾
SOP-8 (FD) (1in ²)	1.2W ⁽²⁾
Thermal Resistance Junction to Case, (θ_{JC})	
SOP-8 (FD)	13°C/W
Storage Temperature	-55~150°C
Operation Temperature	-20~85°C

Note:

⁽¹⁾: Please refer to Minimum Footprint PCB Layout Section.

⁽²⁾: Please refer to 1in² of 1oz PCB Layout Section.

Electrical Characteristics

($V_{OUT} = 5V$, $V_{BAT} = 3.6V$, $L = 2.2\mu\text{H}$, $C_{IN} = 47\mu\text{F}$, $C_{OUT} = 68\mu\text{F}$, $T_A = 25^\circ\text{C}$)

The device is not guaranteed to function outside its operating conditions. Parameters with MIN and/or MAX limits are 100% tested at +25°C, unless otherwise specified.

PARAMETER	SYMBOL	CONDITIONS	MIN	TYP	MAX	UNITS
General						
Input operation voltage	V_{BAT}		2.5	---	4.5	V
Output voltage	V_{OUT}	Line and Load Regulation in CCM (IL>100mA) $V_{BAT}=2.5\sim 4.5$	4.925	5	5.075	V
Input Quiescent current	I_{BAT}	$V_{BAT} = 3.6$ FB=1.28 No load, no switching (exclude input current from ILM01)	---	80	110	μA
Shutdown supply current	I_{BAT}	(ILM01=0 in SOP-8)	---	0.1	1	μA
Oscillator&Protection						
Switching Frequency	F_{osc}		0.35	0.5	0.65	MHz
Soft-Start Interval	SS		4	5	6	ms
FB Regulation Voltage	V_{FB}		1.193	1.211	1.23	V
FB Input Current	I_{FB}	FB=1.0V	---	---	100	nA
T_scp_restart	Restart time in SCP		---	140	---	ms
short-Circuit Response Time	T_short_response	$V_{OUT} < V_{OUT} \times 25\%$	---	Tosc	---	μs
Current Limit Response Time	T_oc_response		---	Tosc	---	μs
Maximum Duty Cycle	D_{max}	FB=0.95V	90	94	97	%
DC-DC Switches						
VOUT Leakage Current	I_{PVOUT_LK}	(ILM01=0 in SOP-8) $V_{OUT}=5V$	---	1	5	μA
LX Leakage Current	I_{LX_LK}	(ILM01=0 in SOP-8) $V_{OUT}=5V$	---	1	5	μA
Switch ON Resistance	R_{ON-N}		---	39	55	m Ω
	R_{ON-P}		---	42	60	
Peak Current Limit	I_{LIM}	ILM01=1	6.5	---	---	A
Efficiency		ILM01=1 $V_{BAT}=3V$, $V_{OUT}=5V$, $I_{OUT}=2A$	---	87	---	%

Electrical Characteristics (Continued)

PARAMETER	SYMBOL	CONDITIONS	MIN	TYP	MAX	UNITS
Protection Block						
VOUT Short-Circuit Threshold	V_{SCP}	Falling Edge	---	$V_{OUT} * 0.5$	---	V
VOUT Short-Circuit Threshold	V_{SCP}	Ring Edge	---	$V_{OUT} * 0.9$	---	V
VBAT UVLO Threshold	V_{UVLO}	Falling Edge	1.7	1.9	2.2	V
VBAT UVLO Threshold	V_{UVLO}	Rising Edge	1.9	2.2	2.5	V
Thermal Shutdown Threshold		Rising Edge, 20°C hysteresis	---	150	---	°C
Control Block						
ILM01 Input High Level	V_{ih_ilm}		1.5	---	5.5	V
ILM01 Input Low Level	V_{il_ilm}		0	---	0.5	V
ILIM01 Internal Pull-Low Resistance	R_{in_ilm}		200	250	300	KΩ

*note1: If ILM01 connect to Vbat, It will consume current $I_{ilm01} = V_{bat} / 250k$

*note2: If IOU is over 2A, The recommended output voltage Vout is below 5.2V.

*note3: $T_{osc} = 1 / F_{osc}$

Minimum Footprint PCB Layout Section

SOP-8 (FD)

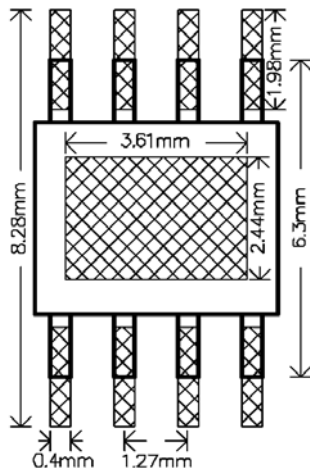

SOP-8 (FD)

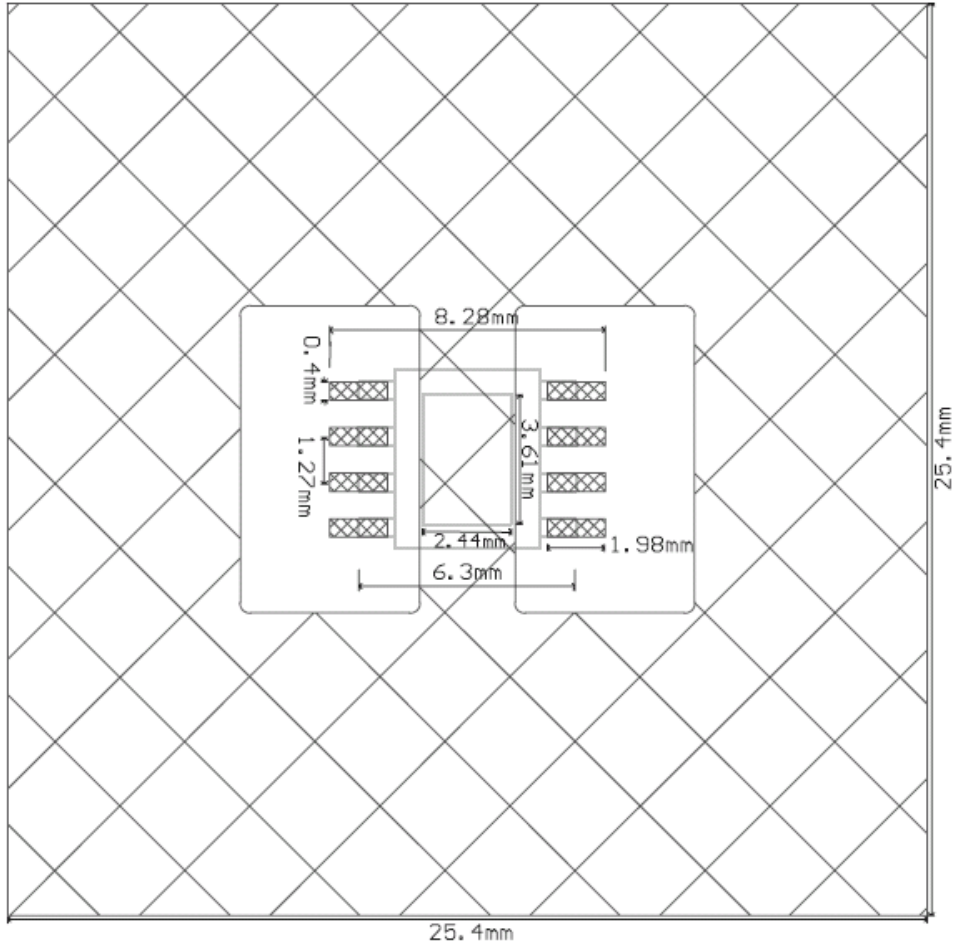

Typical performance Characteristics

($V_{IN}=2.5V\sim 4.2V$, $V_{OUT}=5V$, $C_{IN}=47\mu F$, $C_{OUT}=47\mu F + 22\mu F$, $L=2.2\mu H$, $T_A = 25^\circ C$)

V_{IN}, V_{OUT}, I_L Waveform

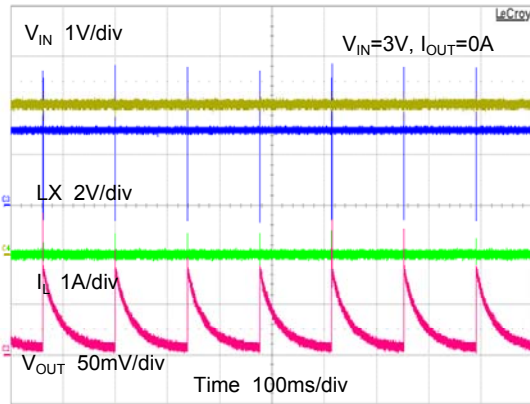

V_{IN}, V_{OUT}, I_L Waveform

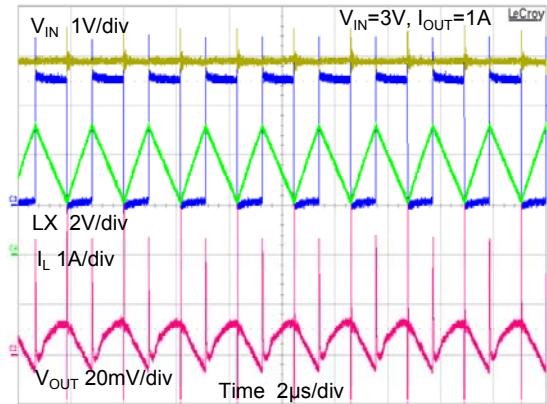

V_{IN}, V_{OUT}, I_L Waveform

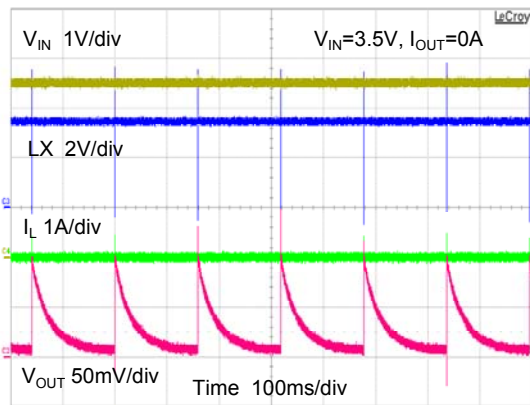

V_{IN}, V_{OUT}, I_L Waveform

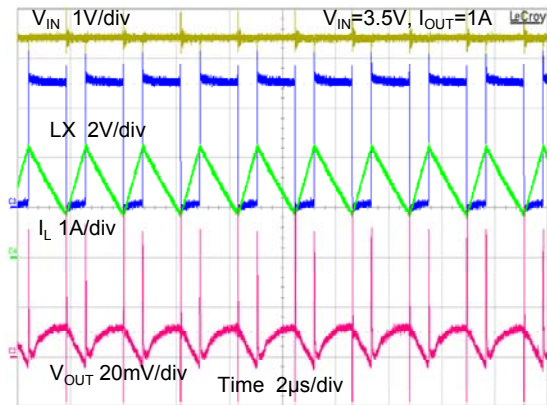

V_{IN}, V_{OUT}, I_L Waveform

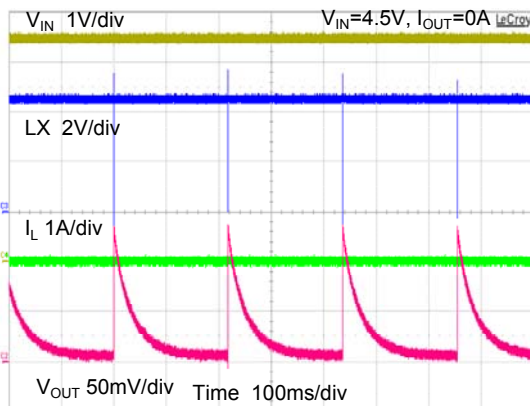

V_{IN}, V_{OUT}, I_L Waveform

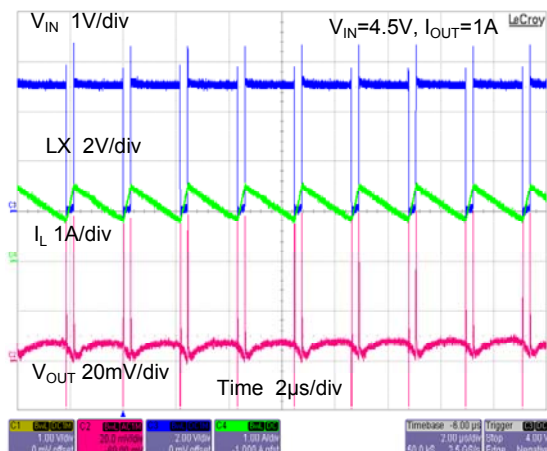

Typical Performance Characteristics (continued)

Start Up Waveform

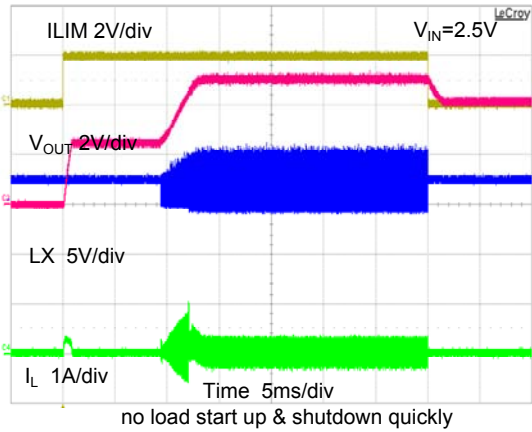

Start Up Waveform

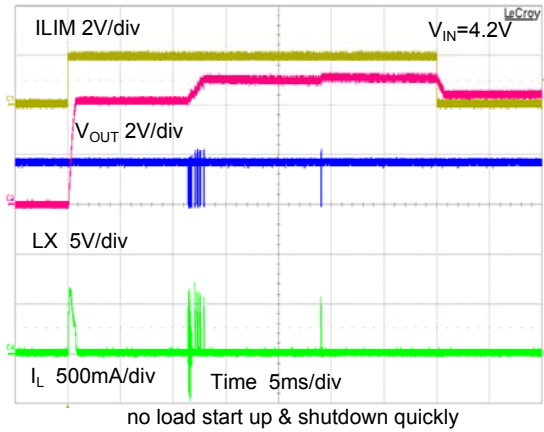

Start Up Waveform

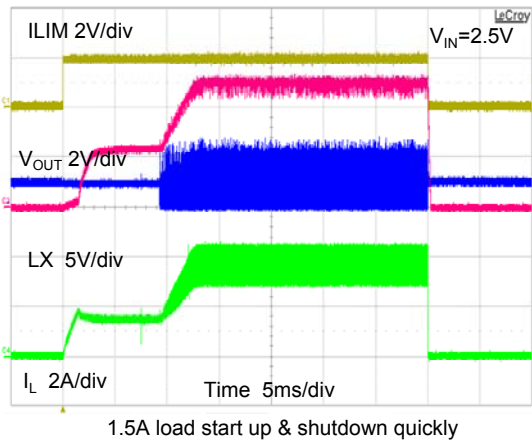

Start Up Waveform

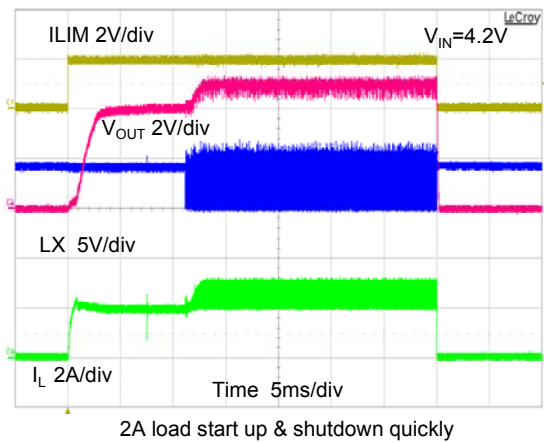

Short Circuit Waveform

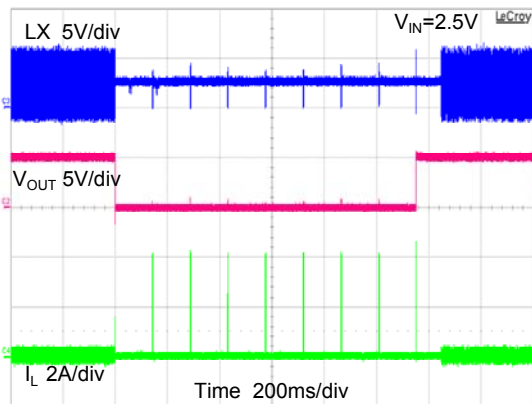

Short Circuit Waveform

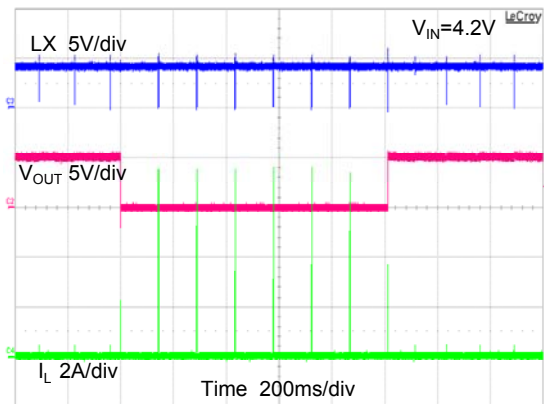

Typical Performance Characteristics (continued)

200mA ~ 1.5A Load Transient Waveform

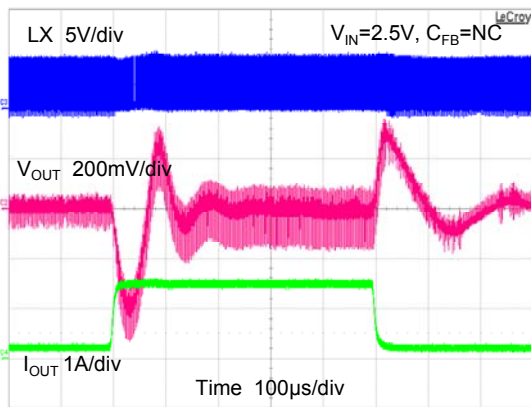

200mA ~ 1.5A Load Transient Waveform

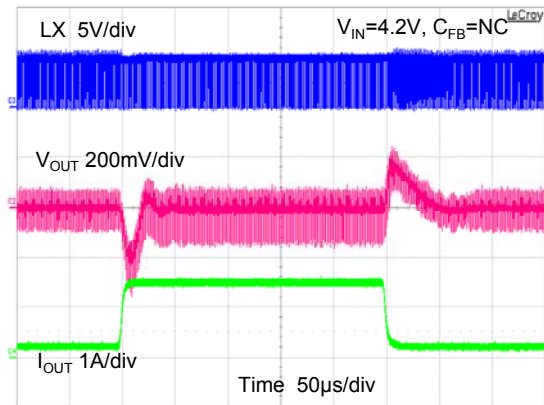

200mA ~ 1.5A Load Transient Waveform

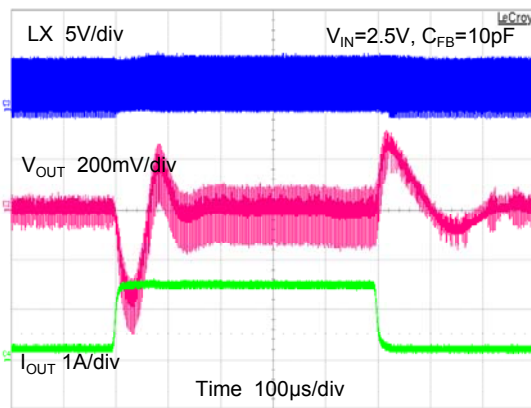

200mA ~ 1.5A Load Transient Waveform

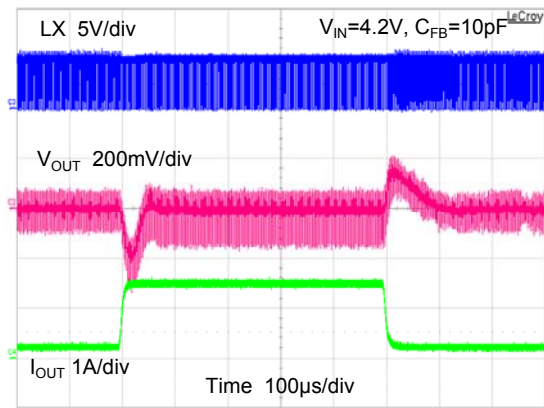

Over Current & Under Voltage Waveform

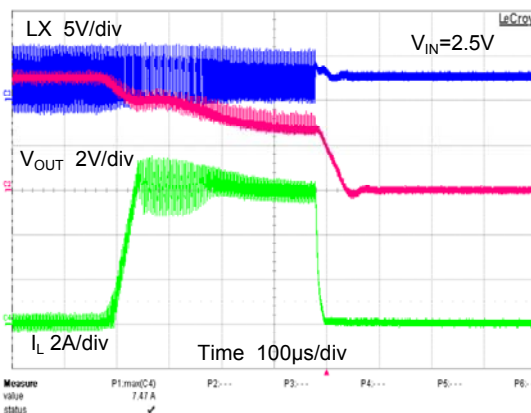

Over Current & Under Voltage Waveform

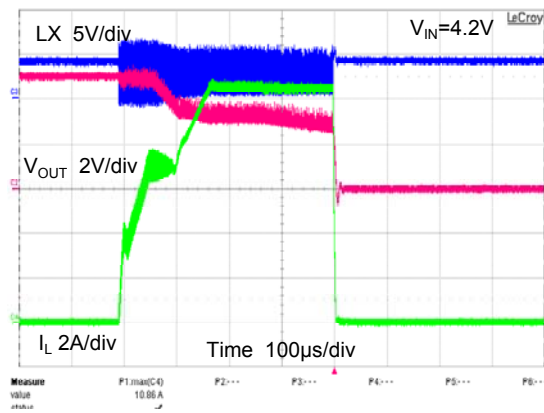

Typical Performance Characteristics (continued)

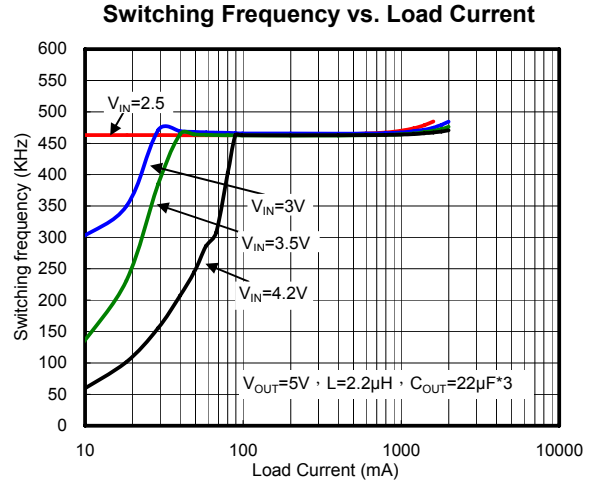
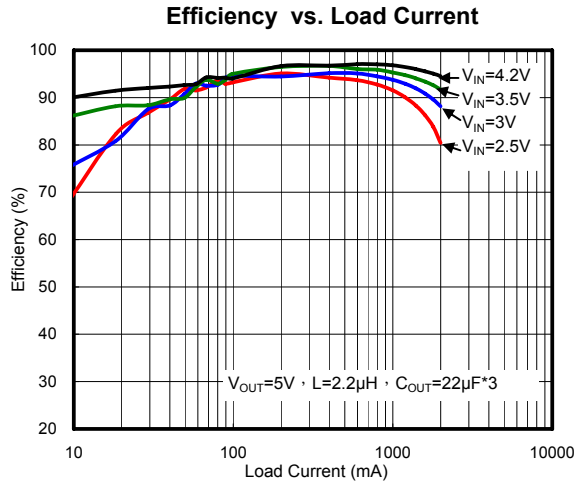

Pin Description for SOP-8 (FD)

PIN	NAME	FUNCTION
1,2	LX	Inductor Node.
3	VBAT	IC Power Supply Input.
4	ILIM01	Output Current Limit Setting, and On/Off Control.
5	GND	IC Analog Ground.
6	FB	Converter Feedback Input.
7,8	VOUT	Converter Output.
	EP	Exposed Paddle. Connect to the ground plane to optimize thermal performance. EP is internally connected to GND. EP must be connected to GND at a single point with a star ground connection.

Block Diagram (For SOP-8 (FD))

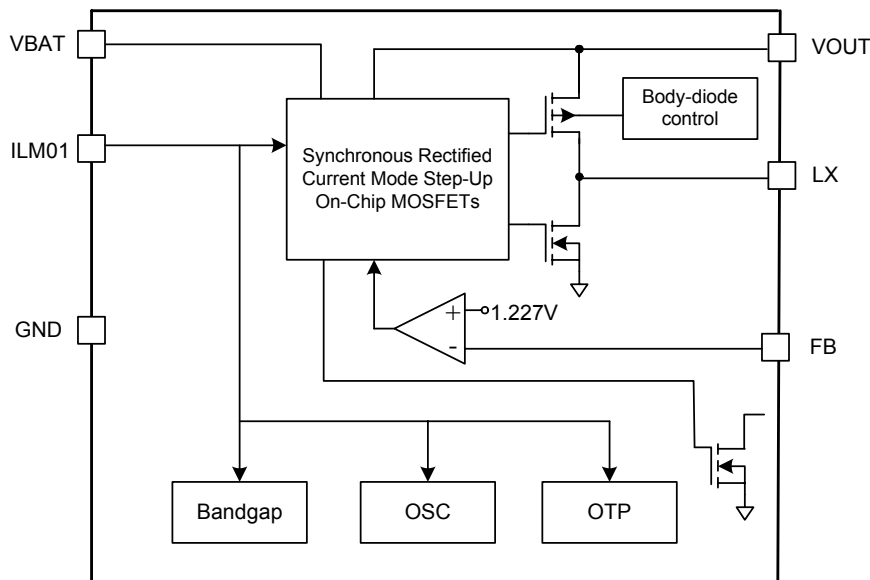

Function Description

The G5177C current-mode step-up DC-DC switching converter uses a fixed-frequency PWM architecture with output shutdown. In light-load mode, the converter switches when needed, consuming only 110µA of quiescent current. In heavy-load mode of higher than 100mA, the converter switches every cycle at a constant frequency as fixed-PWM, thus enabling noise filtering. The G5177C is highly efficient, with internal and synchronous switches. Shutdown reduces the quiescent current to less than 0.1µA. Low quiescent current and high efficiency make this device ideal for portable equipment.

The G5177C step-up DC-DC switching converter typically generates a 5V output voltage from a single-cell battery input voltage. The minimum output peak current limit is 6.5A in SOP8-FD package. When an

over-current, short-circuit or thermal shutdown condition is encountered. The converter will turn off until the over-current or over-temperature condition is removed, and during the state of short-circuit after precharge is end, the converter will turn off 140ms first and then turn on about 2.2ms cycle by cycle to protect converter under short circuit operation. Internal soft-start limits the inrush current to less than 500mA under no-load conditions during startup. The G5177C is adjustable by 2 external resistors with calculating the value for R1 as $R1 = R2 (VOUT/VFB - 1)$.

The G5177C switches at a 500KHz frequency, allowing for tiny external components. The G5177C is optimized for use in iPad-like computers, smart phones, portable handheld devices and other applications requiring low quiescent current for maximum battery life.

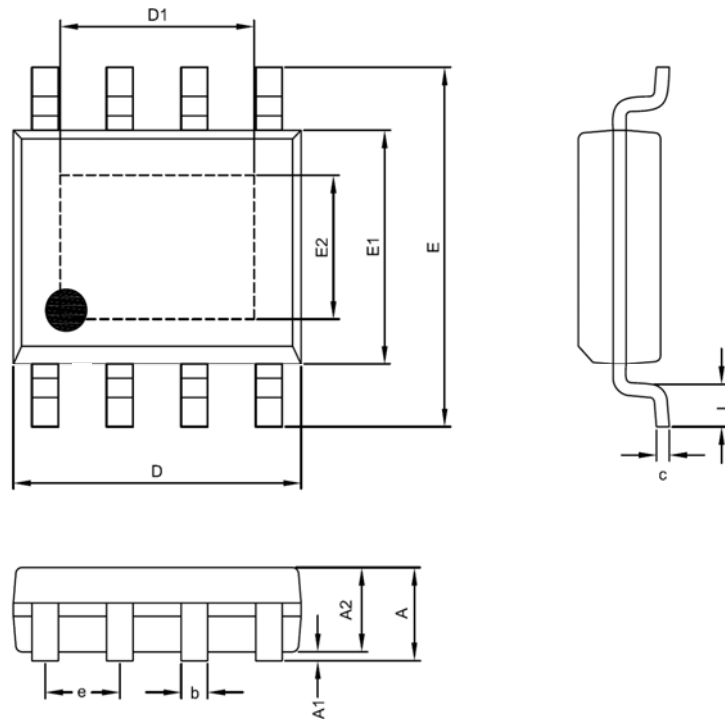
Package Information

SOP- 8 (FD) Package

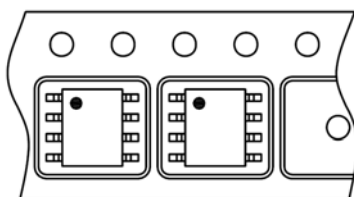
Symble	DIMENSION IN MM			DIMENSION IN INCH		
	MIN.	NOM.	MAX.	MIN.	NOM.	MAX.
A	1.35	1.55	1.60	0.053	0.061	0.063
A1	0.00	---	0.10	0.000	---	0.004
A2	1.15	1.35	1.50	0.045	0.053	0.059
D	4.80	4.90	5.00	0.189	0.192	0.197
D1	2.29	---	3.71	0.090	---	0.146
E	5.80	6.00	6.20	0.228	0.236	0.244
E1	3.80	3.90	4.00	0.150	0.153	0.157
E2	2.29	---	2.64	0.090	---	0.104
c	0.19	0.23	0.27	0.007	0.009	0.011
b	0.33	0.43	0.53	0.013	0.017	0.021
e	1.27 BSC			0.050 BSC		
L	0.40	0.70	1.00	0.016	0.028	0.039

Taping Specification

Feed Direction

PACKAGE	Q'TY/REEL
SOP-8 (FD)	2,500 ea

GMT Inc. does not assume any responsibility for use of any circuitry described, no circuit patent licenses are implied and GMT Inc. reserves the right at any time without notice to change said circuitry and specifications.